

DOOR PLUS



Slide

into tech

Excellence

www.doorplusme.com

DP500



DOOR PLUS

Your space deserves a touch of brilliance

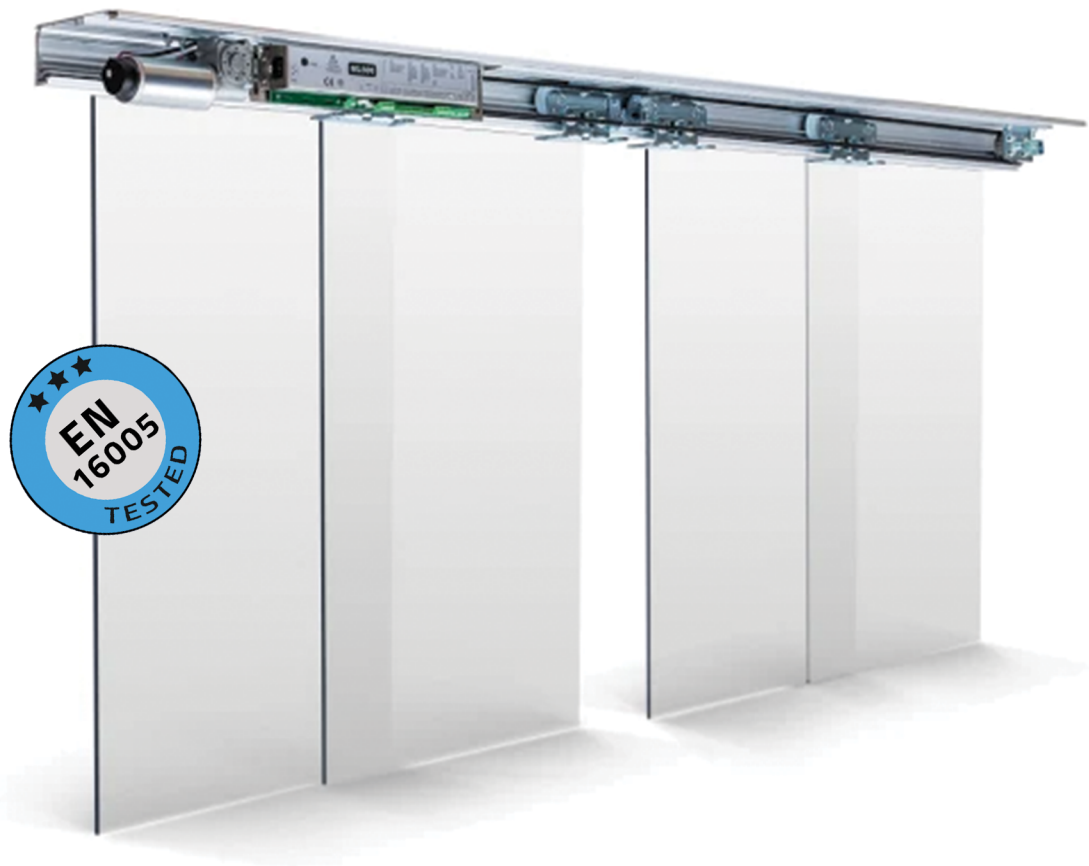

PRODUCT DATASHEET | AUTOMATIC SLIDING DOOR SYSTEM | DP500

A Quality Product With EN16005 Tested & Approved

1 GLIMPSE BRIEFLY

1.1 Short Description

The DP500 Automatic Sliding Door System epitomizes innovation with intelligent micro control and precision machinery manufacturing, ensuring flawless performance. Its smart self-learning system adapts to usage patterns seamlessly. The double track and rubber design guarantee quiet, smooth operation, enhancing both functionality and aesthetics. Safety is paramount, thanks to the special track and hanger design, prioritizing secure door operation. Versatile integration options, monitored battery backup, customizable working times, and a door working cycle memo contribute to a comprehensive solution. The DP500 sets a new standard, seamlessly blending cutting-edge technology, safety features, and adaptability for an unparalleled entrance experience.

1.2 Key Benefits: DP500 Excellence

- Intelligent Micro Control
- Smart Self-Learning System
- Quiet and Smooth Operation
- Built-in Receiver with Learning Code Remote
- Safety-Focused Design
- Versatile Integration
- Monitored Battery Backup
- Customizable Working Times
- Door Working Cycle Memo
- Optional Opening Programs

1.3 Areas of use

The DP500 Automatic Sliding Door System finds versatile applications in various settings, contributing to enhanced accessibility, convenience, and aesthetics. Here are several areas of usage:

- Commercial Spaces
- Office Buildings
- Hospitals and Healthcare Facilities
- Hotels and Hospitality
- Public Transportation Hubs
- Educational Institutions
- Retail Showrooms
- Residential Complexes
- Government and Public Buildings
- Entertainment Venues
- Industrial Facilities
- Shopping Centers
- Automotive Showrooms
- Cultural and Exhibition Spaces

DP500 MORE CONVENIENT

to adjust the controller parameters

Other type



DP500



2 PRODUCT

2.1 Product Description

Sectional Image

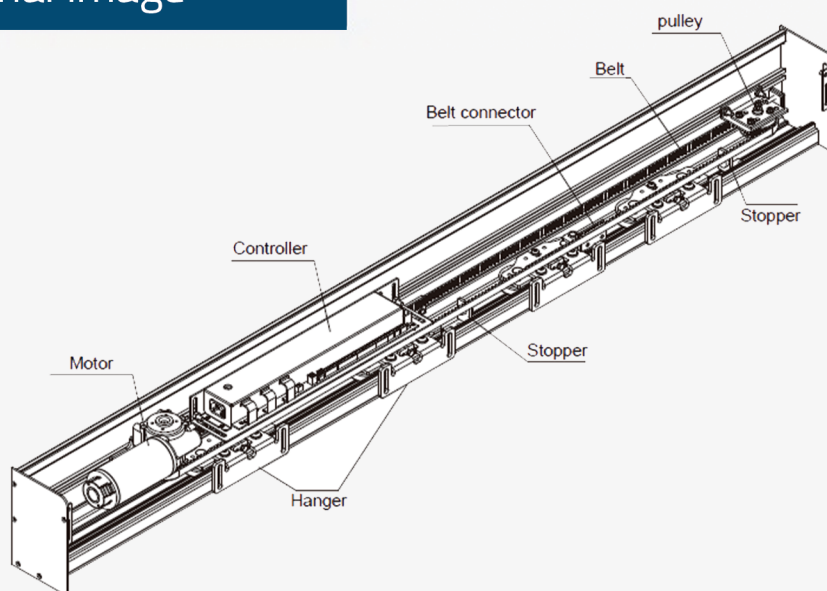

2.1.1 Sectional image describing the inner components of the DP500 - Sliding system

Introducing the DP500 Automatic Sliding Door System, a pinnacle of innovation and functionality designed to redefine entrances across diverse environments. Engineered with intelligent micro control and precision machinery manufacturing, the DP500 ensures unparalleled accuracy and reliability in every movement. Its smart self-learning system adapts seamlessly to usage patterns, optimizing performance for a personalized and efficient user experience.

The DP500 stands out with its double track and rubber design, ensuring a quiet and smooth operation that elevates the aesthetic appeal of any space. The built-in receiver effortlessly integrates with learning code remotes, providing intuitive control and convenience. Safety takes precedence with a special track and hanger design, prioritizing secure and reliable door operation, making it an ideal choice for a wide range of applications.

Versatility is a key feature of the DP500, offering seamless integration with various terminals, including access keypads, photocells, UPS, interlocks, and function switches. This adaptability makes it suitable for commercial spaces, healthcare facilities, educational institutions, residential complexes, and more. The system also features a monitored battery backup, ensuring uninterrupted operation during power outages, and customizable working times for enhanced flexibility.

2.2 Installation of sensor

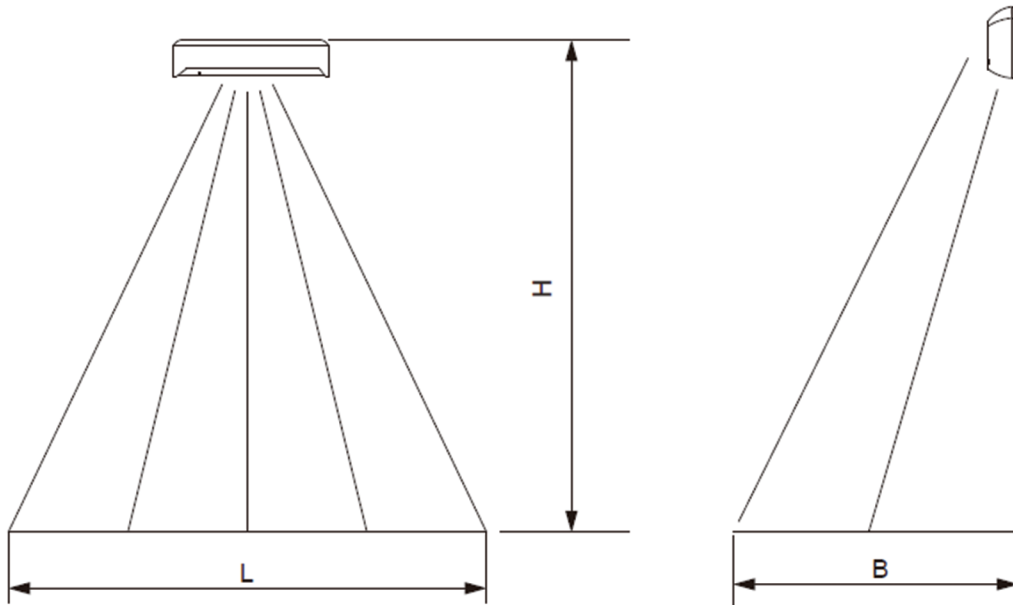

The sensor should be installed at the center of the door leaf.

The max installing height of sensor is 3m.

2.3 Sectional view of track & cover

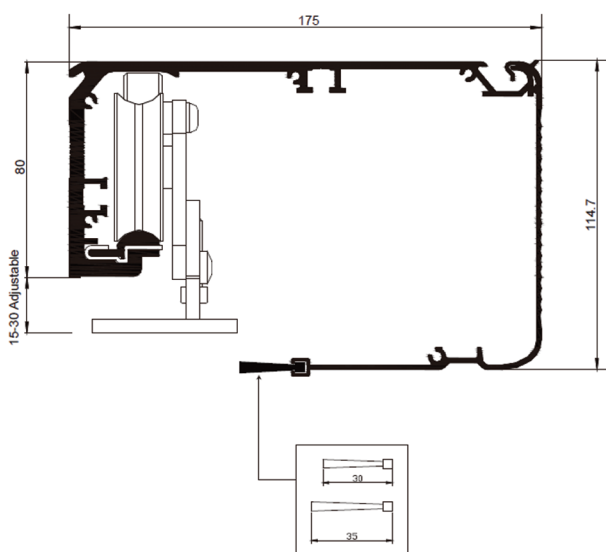

1. DP500 track fitted in slim door header
2. DP500 cover will be together with brush to keep the dust from rail
3. Ruber strip less noise
4. The hanger can pass through behind the motor and controller to ensure the widest opening size

2.5 Terminal details of the controller

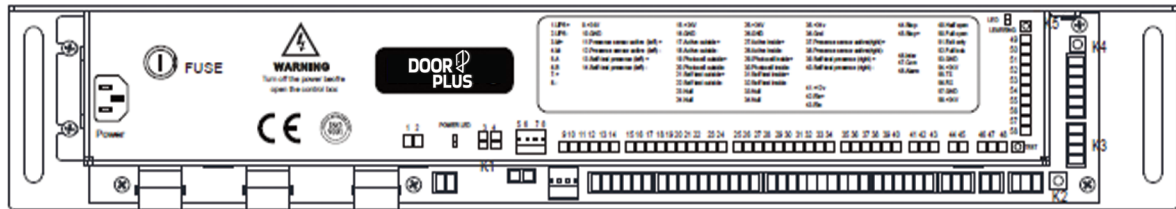

1. UPS+	15. +24V	25. +24V	41. +12v	49. Half open
2. UPS-	16. GND	26. GND	42. Ele+	50. Full open
3. M+	17. Active outside+	27. Active inside+	43. Ele-	51. Exit only
4. M-	18. Active outside-	28. Active inside-	44. Stop-	52. Full lock
5. A	19. Photocell outside+	29. Photocell inside+	45. Stop+	53. GND
6. B	20. Photocell outside-	30. Photocell inside-	46. Inter	54. +24V
7. +	21. Self test outside+	31. Self test inside+	47. Com	55. TX
8. -	22. Self test outside-	32. Self test inside-	48. Alarm	56. RX
	23. Null	33. Null		57. GND
	24. Null	34. Null		58. +24V
9. +24V		35. +24v	K1: POWER LED K2: TEST K3: ADJUST PLUG K4: LEAREING K5: LED	
10. GND		36. Gnd		
11. Presence sensor active (left) +		37. Presence sensor active(right)+		
12. Presence sensor active (left) -		38. Presence sensor active(right)-		
13. Self-test presence (left) +		39. Self-test presence (right) +		
14. Self-test presence (left) -		40. Self-test presence (right) -		

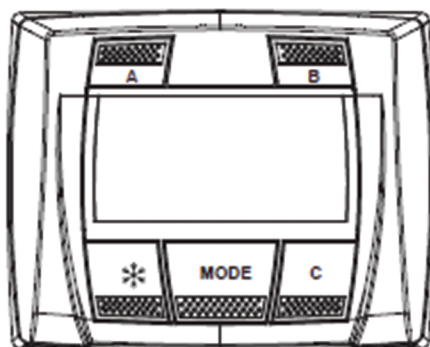

Mode :

Function selector button / confirm button. press 8 seconds, it will become to data adjuster; press 8 seconds again, it will return to function selector.

A : Code setting meaning number 4

B : Code setting meaning number 3

C : Select technical item when working as data adjuster / code setting meaning number 2

* Partial open when function selector / select technical item whendata adjuster / code setting meaning number 1



The door opens by activating any installed opening control



The external sensor is deactivated, all other opening controls remain active.



The internal sensor is deactivated, all other opening controls remain active.



The door opens and remains open permanently.



The door is closed and the sensors not active. The door may only be opened with the Emergency opening button.



The door's automatic mode is deactivated and the leaves can be moved manually.



Press the button * to reduce the passage opening. The percentage of partial opening can be set. If you don't want to partial opening function, please press the button * again.

2.6 Connection & Wiring

Outd1.Connection for OPTEx: OAM-Dual T and OA-Presence TNoor Sensor

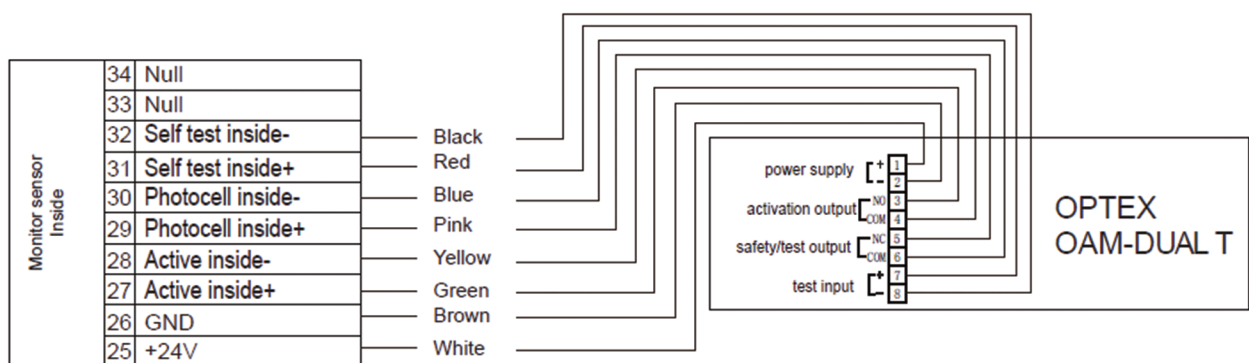

DIP Switch adjustment for Inside sensor

2.7 DP500 web(data adjuster)

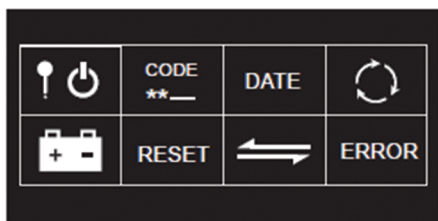

Press button "SET" more then 8 seconds, SPIDER WEB become to data adjuster



Data setting



working times



Re-learning travel distance



Code setting



Battery mode

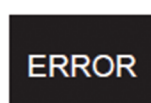

Error warning

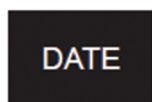

date setting



Data reset

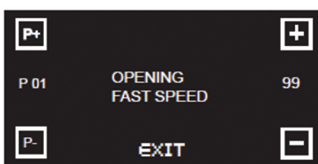

Data setting: press button F2 and * to select code no. P01 to P25. There are 25 items can be setted as customer requested. And press button F1 and F3 to set the value of each code.

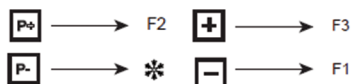

Code no.	Value range	Default value	Details
P01	30-99	80	Opening speed
P02	30-99	65	Closing speed
P03	01-30	05	Braking speed when opening
P04	01-30	05	Braking speed when closing
P05	05-50	30	Braking distance when opening
P06	05-50	30	Braking distance when closing
P07	01-03	02	Auto reverse force when opening
P08	01-03	02	Auto reverse force when closing
P09	01-03	02	Holding force-closed
P10	20%-80%	60%	Partial opening
P11	00-60	6	Door hold time (0-60S)
P12	00-01	00	Aux lock type (00: lock with power, 01: lock without power)
P13	00-01	00	Battery monitoring (00: disabled, 01: enabled)
P14	00-02	00	Battery mode (00: open, 01: closed, 02: automatic)
P15	00-01	00	Fire alarm mode (00: open, 01: closed)
P16	00-03	00	00: Fire alarm equipment signal: NO stop signal: NO 01: Fire alarm equipment signal: NC stop signal: NO 02: Fire alarm equipment signal: NO stop signal: NC 03: Fire alarm equipment signal: NC stop signal: NC

P17	00-07	00	00: Photoell signal: NO Active signal: NO Presence sensor active:NO 01: Photoell signal: NC Active signal: NO Presence sensor active:NO 02: Photoell signal: NO Active signal: NC Presence sensor active:NO 03: Photoell signal: NC Active signal: NO Presence sensor active:NC 04: Photoell signal: NC Active signal: NC Presence sensor active:NO 05: Photoell signal: NC Active signal: NO Presence sensor active:NC 06: Photoell signal: NO Active signal: NC Presence sensor active:NC 07: Photoell signal: NC Active signal: NC Presence sensor active:NC
P18	00-03	01	00:Open direction:left encoder direction:left 01:Open direction:right encoder direction:right 02:Open direction:left encoder direction:right 03:Open direction:right encoder direction:left
P19	00-01	00	Door working mode (00: normal working, 01: toggle working)
P20	00-01	00	Aux lock way (00: lock with signal 01: auto lock each time when closed)
P21	00-01	00	Inner threshold: monitored (00: NO, 01: YES)
P22	00-01	00	Outer threshold: monitored (00: NO, 01: YES)
P23	00-01	00	Right sidescreen: monitored (00: NO, 01: YES)
P24	00-01	00	Left sidescreen: monitored (00: NO, 01: YES)
P25	00-02	00	Working times (00: no limit, 01: 100000, 02: 10000)

2.8 Product specifications

Product features	DP500	DP300
Height	800mm	800mm
Depth	1730mm	1730mm
Profile thickness	8cm	8cm
Leaf weight -1 leaf	250kg	150kg
Leaf weight -2 leaf	2 x 180kg	2 x 140kg
Door leaf width	700-2500 mm	500-2000 mm
Door double width	600-1800 mm	500- 2000mm
Temperature rage	-20c~ +70c	-10c~ +70c
Ip rating	IP20	IP20
Opening speed	20-75 cm/s (adjustable)	10-50 cm /s (adjustable)
Closing speed	20-60cm/s (adjustable)	0-60 cm /s (adjustable)
Opening holding time	0-60 sec (adjustable)	0-60 sec (adjustable)
Interlocking door system function	available	available
Main voltage frequency	AC <100V -250V	AC<100-240 V ,50- 60HZ
Motor power consumption	24v -120w ,DC BRUSHMOTOR	24v -55w
Motor rpm	3600 rpm	2300 rpm
Manufacture according ISO .9001	Yes	Yes
Approval	EN 16005	EN ISO 12100 :2100
	EN ISO 13849-1:2015	EN 60 204 -1
	EN . 2100 :2010	
	EN. 60335	
Certification	TUV certified	
	CE passed	CE passed
	ISO passed ISO 9001 quality - certification	ISO passed ISO 9001 quality certification
	2 million passed trouble free test 24 month warranty	12 month warranty

3.0 Conclusion of DP500

In overview, the DP500 data sheet reflects a product that goes beyond the ordinary, setting a new standard for automatic sliding door systems. With features that cater to a wide array of environments, this system promises an intelligent, reliable, and aesthetically pleasing entrance experience. Elevate your spaces with the DP500 – where innovation meets accessibility.



Elevate Every Entry,
Enrich Every **Spaces**

"Door Plus – where sophistication meets innovation"

DOOR PLUS

www.doorplusme.com

DOORPLUS GmbH, Städte und Gemeinden, 43219 Olat Scholz

Tel +49(0) 7139- 213-694 | Fax +49(0) 7139- 213-594 | E- Service.advise@doorplusme.com

GERMANY