



**BOMBAY
TOOLS** YOUR
INDUSTRIAL
PARTNER

TOOLS &
INSTRUMENTS
FOR EVERY
INDUSTRY

BOMBAY TOOLS

YOUR
INDUSTRIAL
PARTNER

Established in Mumbai in 1980 we at Bombay Tools are leading suppliers of precision measuring instruments & industrial tools. Our brand attributes that makes us a preferred choice for industry experts are:



Innovation

We are constantly looking to add new products to our portfolio that simplifies the workflow & improves safety for our customers



Just In Time inventory

We maintain enough stock so that our partners don't have to block their cash flow with unnecessary inventory



Delivery

We meet the urgent demands for tools & instruments & ensure our order processing system is the leanest



Pricing

Reasonable & sustainable pricing model & fair business policies creates a win-win situation

TOOLS FOR YOU

With our approach of providing industry specific tools we present you three dedicated product categories for **Safety, Measurement & General Tools**

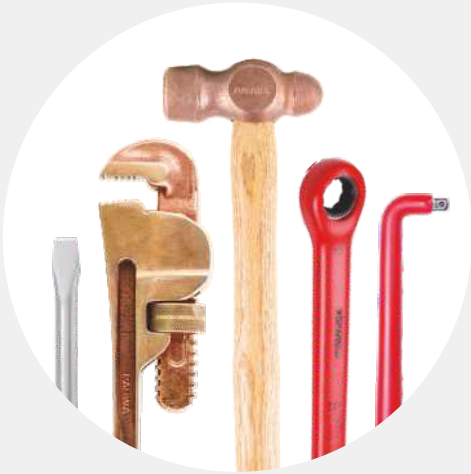

GET SAFE
INDUSTRIAL SAFETY
EQUIPMENT

MEASURE UP
MEASURING EQUIPMENT FOR
INDUSTRIAL NEEDS

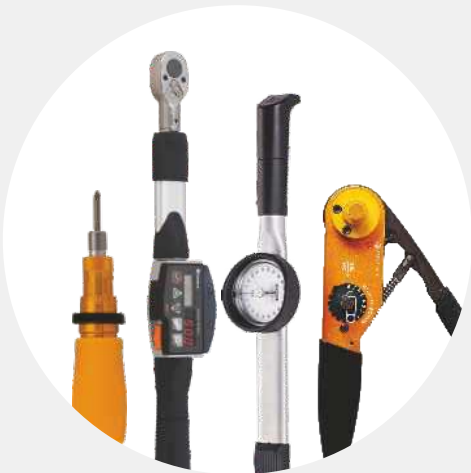

TOOL IT
TOOLS FOR ASSEMBLY,
OPERATION & MAINTENANCE

GET SAFE

INDUSTRIAL SAFETY EQUIPMENT

Get Safe range of products help improve safety in your plant - whether it be working in hazardous locations with highly flammable gases, performing electrical operations & maintenance or ensuring sterile environment is maintained in critical applications. We are proud to introduce our non-sparking tools made from an innovative alloy - Copper Titanium

SPECIALLY FOR INDUSTRIES



Oil & Gas
Industries



Steel
Industries



Chemical &
Fertilizers



Pharmaceuticals
Companies



Automobile
Manufacturing



Power &
Utilities



Cement
Factories



Breweries &
Distilleries



NON-SPARKING HAND TOOLS

Our Non-Sparking Tools are the best alternative to regular steel tools and finds application in potentially explosive environments. Non-Sparking tools are mandatory in any environment where an ignition source can result in a fire or explosion.

Our tools are tested and complies to IS 4595 standard for non-sparking property



Non Sparking



Good Hardness



Corrosion Resistant



Non Magnetic



High Strength



Good Conductivity

INDUSTRIES

Oil & Gas (Upstream, Midstream, Downstream)

Chemical Industry

Pharmaceutical Industry

Automobile Industry

Thermal Power Plants

Fertilizer Plants

Sugar Mills

Breweries & Distilleries

Paint, Lacquer & Varnish Industry

Explosive & Ammunition Plants

Waste Treatment Facilities

First Responders

Applications of Non-Sparking Tools

Need these extensively for various applications

In manufacturing, handling and storage of flammable liquids & gases

Storing and handling of various hazardous chemicals

Maintenance in Paint shops

Handling Hydrogen gas cylinders

Dealing with ammonia gas

Dealing with combustible sugar dust

Manufacturing & storing of alcohols

Handling of solvents & varnishes

Explosive Dust

Presence of flammable vapors

Firefighters and bomb disposal squads

*Note the above list is not exhaustive

MATERIAL COMPOSITION

We offer 2 kinds of materials for non-sparking tools, Copper-Beryllium alloy (Be-Cu) and Aluminium-Bronze (Al-Br) alloy:

COPPER-BERYLLIUM ALLOY		ALUMINIUM-BRONZE ALLOY	
Composition	Be: 1.8%-2% Ni: 0.2%-0.5% Others: <0.5% Rest: Cu	Composition	Al: 10%-12% Ni: 2%-5% Fe: 1.5%-3% Others: <0.5% Rest: Cu
Hardness	35-40HRC	Hardness	25-30HRC
Tensile Strength	~1100	Tensile Strength	~800 N/mm ²



D/E OPEN SPANNER
6X7mm to 46X50mm



D/E RING SPANNER
6X7mm to 46X50mm



COMBINATION SPANNER
6mm to 50mm



SLOGGING OPEN SPANNER
17mm to 150mm



SLOGGING RING SPANNER
17mm to 150mm



BALL PEIN HAMMER
230g, 340g, 450g, 910g



CLAW HAMMER
230g, 450g, 910g



SLEDGE HAMMER
450g to 9900g



ADJUSTABLE WRENCH
6" TO 36"



PIPE WRENCH
8" TO 36"



ALLEN KEY
1.5mm to 41mm
1/16" TO 1"

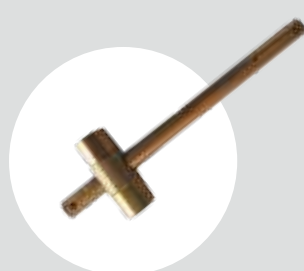

CYLINDER KEY
1.5mm to 12mm



COMBINATION PLIER
6", 8"



LONG NOSE PLIER
6", 8"



DIAGONAL CUTTING PLIER
6", 8"

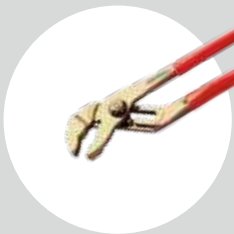

GROOVE JOINT PLIER
12"



WIRE STRIPPING PLIER



BUNG WRENCH



FLAT SCREWDRIVER
50mm to 350mm



PHILLIPS SCREWDRIVER
50mm to 350mm

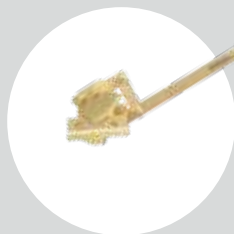

DRUM OPENER



HACKSAW FRAME



HACKSAW BLADE
300mm



CYLINDER KEY



CLAMP



FUNNEL



SCRAPPERS



CHISELS



PUTTY KNIFE
75mm, 100mm, 150mm



FILES
6", 8", 10", 12"



IMPACT SOCKET
6mm to 32mm

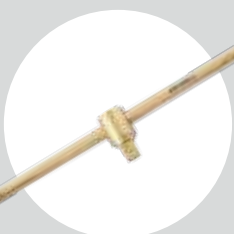

SLIDING T HANDLE



DRIVER EXTENSION



RATCHET WRENCH
1/2" to 3/4"



FIREMAN AXE



CARBIDE DRUM OPENER



NON SPARKING TOOLKIT
21 PC SET



EMERGENCY TOOLKIT
OISD 117



SOCKET SET 17 PCS



SOCKET SET 32 PCS



NON SPARKING TOOLKIT
26 PC SET

USE NON-SPARKING TOOLS IF

<p>You are loading/unloading solvents & other chemicals in your plant</p>	<p>You perform regular maintenance of paint shops in an automotive industry</p>	<p>You are operating an Oil & Gas storage & distribution plant such as a terminal or depot</p>
<p>You perform maintenance of tanks & other structures in an Oil & Gas plant</p>	<p>You operate a bottling facility for LPG or other flammable gases</p>	<p>Your plant requires a regular feed of highly combustible gases such as hydrogen, butane, methane, propane or produces residual gases that are flammable</p>
<p>Cleaning & maintenance of chemical reactors</p>	<p>Operation & maintenance of LPG & LNG bullets</p>	

Note: The above list is not exhaustive & you should consult your Health & Safety team for best practices

INSULA

INSULATED HAND TOOLS FOR ELECTRICAL SAFETY

1000 Volts insulated tools

Electrical Cars, Automation, IoT, & AI in the Industrial space are already here. To support new as well as existing technologies requires the industry to maintain labyrinth network of electrical cables, circuitries & panels. In our quest to be more intelligent 'safety' cannot be neglected at any point. For regular operations & maintenance of electrical equipment & circuitry requires the correct set of tools. Our full range of Insulated Hand Tools have been providing to the industry the tools needed for the above.

Why 1000 Volts insulated tools?

The working end (business end) of hand tools are made from regular steel or chrome vanadium. This poses a major risk of shock for operators performing electrical operation or maintenance. Insulated tools are basically made from regular steel alloy with a PVC insulation that is applied using either of the 2 processes – dipping or injection moulding. Both these processes are carefully applied to each tool to ensure correct amount of insulation.

WHY INSULA



When working in live wires/ systems these tools provide insulation from electric shock



During electrical ops & maint systems remain energized even after shutdown. These tools provide safety to operator from fatal shock

SPECIALLY FOR INDUSTRIES

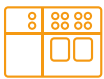

Control Panels



Live Wires



Batteries



Electricals Cars



Busbars



OPEN SPANNER
6mm to 32mm



RING SPANNER
6mm to 32mm



RING GEAR WRENCH
10mm to 19mm



ADJUSTABLE WRENCH
200mm, 250mm, 300mm



SOCKET WRENCH
8mm to 19mm



ALLEN KEY
3mm to 12mm



SOCKETS (1/2" SQ DR)
10mm to 32mm



RATCHET HANDLE



T-HANDLE



L-HANDLE



TORQUE WRENCH



COMBINATION PLIER
160mm, 200mm



DIAGONAL CUTTING PLIER
160mm, 180mm



LONG NOSE PLIER
160mm, 180mm



CABLE SHEAR
160mm, 180mm



SLOTTED SCREWDRIVER
75mm to 150mm



PHILLIPS SCREWDRIVER



CABLE KNIFE



SCREWDRIVER SET
12PC



INSULATED TOOLKIT
25 PC SET



INSULATED TOOLKIT
52 PC SET



OPEN END SPANNER SET
20 PC SET



RING END SPANNER SET
20 PC SET

STERILA

STAINLESS STEEL HAND TOOLS

Contamination is a serious threat in Food & Drug manufacturing. FDA enforces cGMP to ensure systems that assure proper design, monitoring, and control of manufacturing processes and facilities. Hand Tools used in maintenance in a critical environment needs very high resistance to corrosion. This property ensures that tools can be sterilized through multiple cycles

Our range of SS tools (SS304 and SS316) are perfectly suited for the above environments in the Food and Pharma industry. We offer a complete range of tools that may be needed in injectables and other applications that will mitigate risks of contamination and help manufacturers with strong cGMP and adherence to FDA rules.

WHY **SS304**



Comparatively Soft, cannot be Hardened



Non-Magnetic



Widely used in Organic and Inorganic Chemicals, Dyes, Food & Pharma Industries



High level of Corrosion and Oxidation resistance by most Organic and Inorganic Chemicals

WHY **SS316**



Autoclavable



Non-Magnetic



Higher level of Corrosion Resistance than SS304, Resistant to most Chemicals



Suitable for FDA Compliant Production and Packaging Areas

WHY USE TOOLS MADE FROM STAINLESS STEEL?

- Our stainless steel alloy tools can be sterilized repeatedly in an autoclave
- SS tools do not contaminate other SS components & prevents rusting & corrosion
- It is well suited for a non-magnetic application
- Our SS tools have over 10% chromium. Chrome forms an invisible layer of chromium oxide which protects the core from rusting
- If the tool layer is damaged mechanically or chemically oxidation will repair the layer again

Risk of Process Contamination

Low

Particulate Generation

Homogenous material- No plating/ coating to peel/ chip

Sterility

Designed specifically for routine sterilization through thousands of cycles

Ferrous Contamination

Pure chromium oxide surface creates passive (non-reactive) layer with no iron contamination

Cost

Long life of the tools eliminates need for replacement & quickly maximizes return on investment

Design

Designed & specified for critical environment applications

Critical Environment

No negative impact on critical environments



D/E RING WRENCH
Size in mm: 6 x 7 to 30 x 32



CROSS PEIN HAMMER
Weight in gm: 450



COMBINATION WRENCH
Size in mm: 6 to 32



D/E OPEN WRENCH
Size in mm: 6 x 7 to 30 x 32



ADJUSTABLE WRENCH
Size in inch: 6, 8, 10, 12, 15



HAMMER
Weight in gm: 230, 450



SLOTTED SCREWDRIVER
Size in inch: 6, 8, 10, 12



PHILLIPS SCREWDRIVER
Size in inch: 6, 8, 10, 12



COMBINATION PLIER
Size in inch: 8



ADJ COMBINATION PLIER
Size in inch: 8



T-TYPE HEX KEY BALL END
Size in mm: 3 to 10



WATER PIMP PLIER
Size in inch: 10, 12



LONG NOSE PLIER
Size in inch: 8



ALLEN KEY
Size in mm: 1.5 to 12



MINI PLIER
Size in inch: 6



DIAGONAL CUTTING PLIER
Size in inch: 8

MEASURING SOLUTIONS FOR THE FOLLOWING CATEGORY OF APPLICATIONS

GENERAL MEASUREMENT

There is no industry worldwide that can operate without these staple measuring instruments – Vernier Calipers, Micrometers, Dial Gauges, Height Gauges, etc. These tools are necessary in production, QA & inspection, workshop, labs etc. While there are plenty of suppliers for these products in the market those offering genuine instruments are very few. Bombay Tools is a name that you can trust to provide you genuine gauges at economical pricing. Please see our below range of products & feel free to inquire with us for more complex needs.



VERNIER CALIPERS



MICROMETERS



SURFACE ROUGHNESS TESTER



DIAL GAUGES



HEIGHT GAUGE



OIL DIP TAPE

NDT, PAINT & SURFACE TESTING EQUIPMENT

Non-destructive testing has seen huge innovations in the last 3 decades. Inspection equipment for coatings & metal industry now offers a plethora of solutions for inspections at various construction sites, industrial plants, labs as well as to coating service providers. Similarly in the metal & rubber industry a range of NDT equipment is available for measuring metal hardness, thickness, flaws, profiles, films, cracks, etc.



ELCOMETER UK COATING THICKNESS GAUGE



PRECIGAUGUE COATING THICKNESS GAUGE



ULTRASONIC THICKNESS GAUGE

NDT, PAINT & SURFACE TESTING EQUIPMENT



CROSS HATCH CUTTER



FORD CUP



PRESS O FILM



SURFACE PROFILE GAUGE



HARDNESS TESTERS



WET FILM THICKNESS (WFT) GAUGE

ATMOSPHERIC TESTING INSTRUMENT

We offer solutions for measuring various environmental/atmospheric parameters such as temperature, sound, light, vibration, humidity & RPM. You may need the same for your compliance check or to monitor & maintain temperature & humidity in a lab environment. Those within the HVAC industry need these instruments for their installations. Monitor & optimize light levels, reduce the energy burden of buildings by significantly increasing the efficiency of the lighting system with a light meter. Or check the moisture content of building materials for water damage or harmful mould growth, using a moisture meter. Whatever the application we have a solution for you.



ANEMOMETER (WIND VELOCITY METER)



TACHOMETER (RPM METER)



INFRARED THERMOMETER



LUX METER



SOUND LEVEL METER



VIBRATION METER

ATMOSPHERIC TESTING INSTRUMENT



**THERMO
HYGROMETER**



**ALCOHOL
TESTER**



**MULTI-GAS
DETECTOR**

WELDING INSPECTION GAUGES

Inspection of welds is simplified with our full range of weld gauges below. You can measure Weld Throat Thickness, Butt Fillet Type Welds, Weld Length, Misalignments (High-Low) as well as pits & undercuts.



**BRIDGE CAM
GAUGE**



**FILLET WELD
GAUGE**



**DIGITAL WELD
GAUGE**



AWS WELD GAGE



**V-WAC SINGLE
WELD GAGE**



**INSPECTION
MIRRORS**

BRANDS THAT TRUST **MEASURE UP**

- ISRO
- Siemens
- Godrej
- Larsen & Toubro
- Rosenberger
- BDL
- BEML
- Ordnance Factory
- Ultratech Cement
- SHV Gas
- Hathway
- Reinhardt
- Dreager

TOOLIT

TOOLS FOR ASSEMBLY, OPERATION & MAINTENANCE

Tools for assembly, Operations & Maintenance

We offer limited albeit highly durable & quality tools under our ToolIt Range of products. We offer Tohnichi & Britool Torque Wrenches for the automotive & other specialized industries where high torque accuracy is critical. At the lower end of the spectrum we offer Indian torque wrenches that are workshop grade & useful for general applications where accuracy is not very critical.

Surface Plates & straight edges are a common requirement in all manufacturing facilities as well as labs as horizontal reference plane for precision inspection, layout & tooling setup.

SPECIALLY FOR INDUSTRIES



Textile
Industries



Engineering
Companies



Telecomm-
unication



FMCG
Manufacturing



TORQUE WRENCH



BRITool TORQUE WRENCHES



INDIAN TORQUE WRENCHES



TOHNICHI JAPAN TORQUE WRENCHES



TORQUE MULTIPLIERS



DIGIAL TORQUE WRENCH



TORQUE SCREWDRIVER

MACHINE TOOLS



SURFACE PLATE



STRAIGHT EDGES



VEE BLOCKS

BRANDS THAT TRUST **TOOL IT**

- Rane NSK Group
- Hero Moto Corp
- SHV Gas
- Hathway
- Reinhardt
- Ceat Ltd
- RPG Group
- Hindalco Industries Ltd
- Indian Oil Tanking
- Deccan Fine
- Powermech
- Offshore Infrastructures Ltd

YOU SHOULD BE USING **TOOL IT** PRODUCTS IF

You are a service & maintenance engineer requiring durable & ergonomic tools

Your team is tasked with installing new machinery esp with space constraints

You are running a workshop or lab that requires perfect tooling setup

BOMBAY TOOLS

YOUR
INDUSTRIAL
PARTNER



Scan the QR code
for more Varients

Bombay Tools Centre (Bombay) Pvt Ltd

Plot 22H, 224 Nesbit Compound,
Opposite Jupiter Tower/ SBI Bank,
Nesbit Road Mazagaon, Mumbai 400010

☎ 022 66668781/ 82/ 83

✉ info@bombaytools.in

Follow us on:

[f](#) [t](#) [in](#) /thebombaytools

www.bombaytools.in

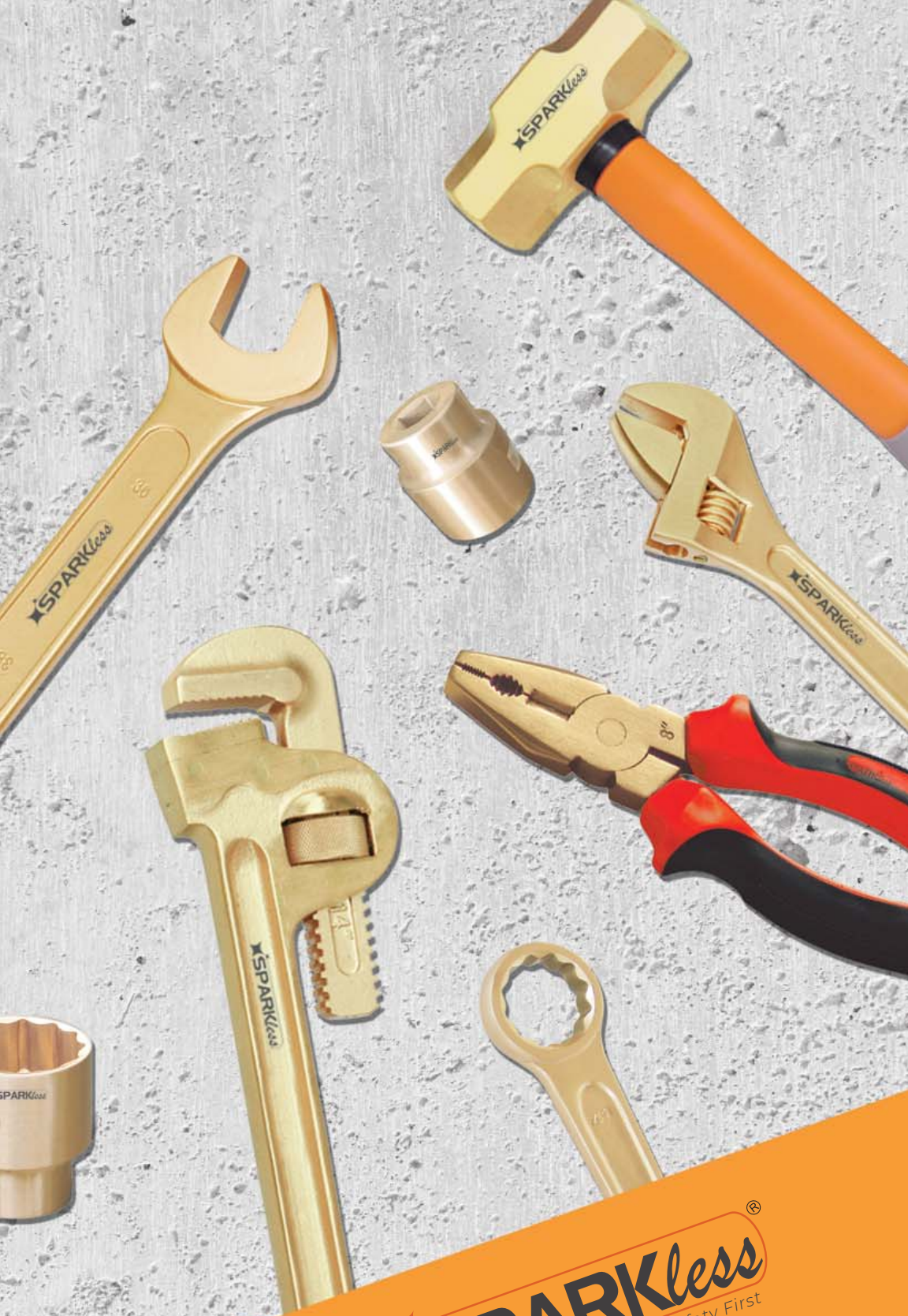

SPARKless[®]
Safety First

Non Sparking Safety Tools
Version 2.01

GETSAFE

INDUSTRIAL SAFETY EQUIPMENT



Our Non-Sparking Tools are the best alternative to regular steel tools and finds application in potentially explosive environments. Non-Sparking tools are mandatory in any environment where an ignition source can result in a fire or explosion.

Our tools are tested and complies to IS 4595 standard for non-sparking property



Non Sparking



Good Hardness



Corrosion Resistant



Non Magnetic



High Strength



Good Conductivity

INDUSTRIES

Oil & Gas (Upstream, Midstream, Downstream)

Chemical Industry

Pharmaceutical Industry

Automobile Industry

Thermal Power Plants

Fertilizer Plants

Sugar Mills

Breweries & Distilleries

Paint, Lacquer & Varnish Industry

Explosive & Ammunition Plants

Waste Treatment Facilities

First Responders

*Note the above list is not exhaustive

Applications of Non-Sparking Tools

Need these extensively for various applications

In manufacturing, handling and storage of flammable liquids & gases

Storing and handling of various hazardous chemicals

Maintenance in Paint shops

Handling Hydrogen gas cylinders

Dealing with ammonia gas

Dealing with combustible sugar dust

Manufacturing & storing of alcohols

Handling of solvents & varnishes

Explosive Dust

Presence of flammable vapors

Firefighters and bomb disposal squads

MATERIAL COMPOSITION

We offer 2 kinds of materials for non-sparking tools, Copper-Beryllium alloy (Be-Cu) and Aluminium-Bronze (Al-Br) alloy:

COPPER-BERYLLIUM ALLOY	
Composition	Be: 1.8%-2% Ni+Co: 0.2%-1.2% Others: <0.5% Rest: Cu
Hardness	283-365 Brinell
Tensile Strength	~1250 N/mm ²

ALUMINIUM-BRONZE ALLOY	
Composition	Al: 10%-12% Ni: 4% - 6% Fe+Mn: <5.8% Others: <0.5% Rest: Cu
Hardness	229-291 Brinell
Tensile Strength	~800 N/mm ²



SOCKET 1/2" SQ DR

DIN3120 Die forged

P/N	S mm	L mm
SJD-6	6	40
SJD-7	7	40
SJD-8	8	40
SJD-9	9	40
SJD-10	10	40
SJD-11	11	40
SJD-12	12	40
SJD-13	13	40
SJD-14	14	40
SJD-15	15	40
SJD-16	16	40
SJD-17	17	40
SJD-18	18	42
SJD-19	19	42
SJD-20	20	42
SJD-21	21	43
SJD-22	22	43
SJD-23	23	43
SJD-24	24	43
SJD-25	25	43
SJD-26	26	43
SJD-27	27	46
SJD-28	28	46
SJD-29	29	46
SJD-30	30	46
SJD-32	32	46

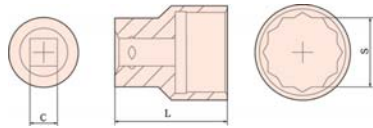

P/N	S in	L mm
SJD-1002	5/16"	40
SJD-1004	3/8"	40
SJD-1006	7/16"	40
SJD-1008	1/2"	40
SJD-1010	9/16"	40
SJD-1012	5/8"	40
SJD-1014	11/16"	40
SJD-1016	3/4"	42
SJD-1018	13/16"	43
SJD-1020	7/8"	43
SJD-1022	15/16"	43
SJD-1024	1"	43
SJD-1026	1-1/16"	46
SJD-1028	1-1/4"	46
SJD-1030	1-7/16"	46



IMPACT SOCKET 1" SQ DR

DIN3129 Die forged

P/N	S mm	L mm
SJH-19	19	55
SJH-21	21	55
SJH-22	22	55
SJH-24	24	55
SJH-26	26	55
SJH-27	27	55
SJH-29	29	60
SJH-30	30	60
SJH-32	32	60
SJH-34	34	60
SJH-35	35	60
SJH-36	36	60
SJH-38	38	65
SJH-41	41	65
SJH-46	46	70
SJH-50	50	75
SJH-52	52	75
SJH-55	55	75
SJH-58	58	85
SJH-60	60	85
SJH-65	65	85
SJH-70	70	90
SJH-75	75	90
SJH-80	80	90

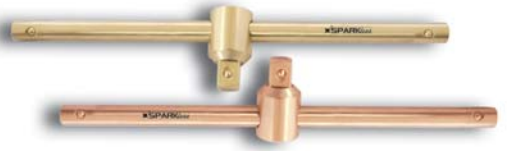

SLIDING T HANDLE

DIN3122 Die forged

P/N	C inch	L mm	H mm	Φ mm
SKG-1002	1/2"	250	39	13
SKG-1004	3/4"	350	54	19
SKG-1006	3/4"	400	56	21
SKG-1008	1"	400	62	21

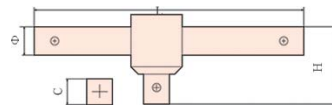

RATCHET WRENCH

Die forged



P/N	C inch	L mm	H mm
SKI-1002	1/4"	200	16.5
SKI-1004	3/8"	175	16.5
SKI-1006	3/8"	200	16.5
SKI-1008	1/2"	250	16.5
SKI-1010	3/4"	300	22
SKI-1012	1"	300	22

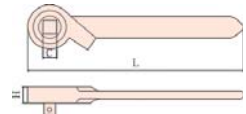

DRIVER EXTENSION

Die forged



P/N	C in	L mm
SLB-1002	3/8"	75
SLB-1004	3/8"	150
SLB-1006	1/2"	100
SLB-1008	1/2"	125
SLB-1010	1/2"	200
SLB-1012	1/2"	250
SLB-1014	3/4"	200
SLB-1016	1	200



SOCKET SET 1/2" SQ DR 17PCS



P/N	CONTENTS	mm
SJAG	Socket	10, 11, 12, 14, 17, 19, 22, 24, 27 30, 32
	Ratchet Wrench	245
	Sliding T-Handle	250
	Speed Handle	400
	Driver Extension	125, 250

SOCKET SET 1/2" SQR DR 32PCS



P/N	CONTENTS	mm
SJAJ	Socket	8, 9, 10, 11, 12, 13, 14, 15, 16, 17, 18, 19, 20, 21, 22, 23, 24, 26, 27, 28, 30, 32
	Spark Plug	13/16"
	Ratchet Wrench	245
	Sliding T-Handle	250
	Speed Handle	400
	Driver Extension	125, 250
	Unviversal Joint	80
	Screwdriver Socket	52
	Offset Handle	230

TORQUE WRENCH

GB/T 15729 Die forged



P/N	C in	Torque N.m	L mm
SDI-1004	1/2"	10-100	405
SDI-1006	1/2"	20-200	500



ADJUSTABLE WRENCH

P/N	L mm	K mm
SLE-1002	100	13
SLE-1004	150	18
SLE-1006	200	24
SLE-1008	250	30
SLE-1010	300	36
SLE-1012	375	46
SLE-1014	450	55
SLE-1016	600	65



PIPE WRENCH

DIN3122 Die forged

P/N	L mm	K mm
SMZ-1002	200	25
SMZ-1004	250	30
SMZ-1006	300	40
SMZ-1008	350	50
SMZ-1010	450	60
SMZ-1012	600	75
SMZ-1014	900	125
SMZ-1016	1200	150

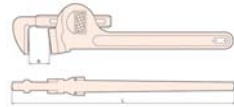

CYLINDER KEY

P/N	L mm	□ mm
CYD-1008A	150	8



COMBINATION SPANNER

Die forged

P/N	S mm	L mm
SME-6	6	105
SME-7	7	120
SME-8	8	120
SME-9	9	135
SME-10	10	135
SME-11	11	150
SME-12	12	150
SME-13	13	175
SME-14	14	175
SME-15	15	195
SME-16	16	195
SME-17	17	195
SME-18	18	215
SME-19	19	215
SME-20	20	230
SME-21	21	230
SME-22	22	245
SME-23	23	265
SME-24	24	265
SME-25	25	265
SME-26	26	290
SME-27	27	290
SME-30	30	320
SME-32	32	340
SME-34	34	360
SME-35	35	360
SME-36	36	360

P/N	S in	L mm
SMEA-1002	1/4"	105
SMEA-1004	5/16"	120
SMEA-1006	3/8"	135
SMEA-1008	7/16"	150
SMEA-1010	1/2"	175
SMEA-1012	9/16"	175
SMEA-1014	19/32"	195
SMEA-1016	5/8"	195
SMEA-1018	11/16"	195
SMEA-1020	3/4"	215
SMEA-1022	13/16"	230
SMEA-1024	7/8"	245
SMEA-1026	15/16"	265
SMEA-1028	1"	290
SMEA-1030	1-1/16"	290
SMEA-1032	1-1/8"	320
SMEA-1034	1-3/16"	320
SMEA-1036	1-1/4"	340
SMEA-1038	1-5/16"	360
SMEA-1040	1-3/8"	360

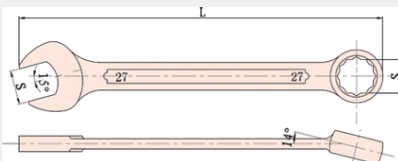



DOUBLE ENDED RING SPANNER

Die forged

P/N	S1*S2 mm	L mm
SOA-0607	6*7	115
SOA-0809	8*9	130
SOA-1011	10*11	140
SOA-1213	12*13	160
SOA-1415	14*15	220
SOA-1617	16*17	220
SOA-1819	18*19	250
SOA-2123	21*23	285
SOA-2427	24*27	340
SOA-2528	25*28	350
SOA-3032	30*32	380
SOA-3236	32*36	405
SOA-3436	34*36	420
SOA-3641	36*41	445
SOA-4146	41*46	470
SOA-4650	46*50	490
SOA-5055	50*55	510
SOA-1258	1/2"BS*5/8"BS	480

(7/16WW*9/16WW)

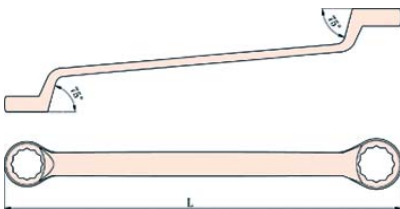

P/N	S1*S2 in	L mm
SOC-1002	1/4"*5/16"	115
SOC-1004	5/16"*3/8"	125
SOC-1006	3/8"*7/16"	140
SOC-1008	7/16"*1/2"	155
SOC-1010	1/2"*9/16"	175
SOC-1012	9/16"*5/8"	215
SOC-1014	5/8"*11/16"	220
SOC-1016	11/16"*3/4"	245
SOC-1018	3/4"*13/16"	255
SOC-1020	13/16"*7/8"	275
SOC-1022	7/8"*15/16"	305
SOC-1024	15/16"*1"	310
SOC-1026	1"*1-1/16"	330
SOC-1028	1-1/16"*1-1/8"	330
SOC-1030	1-1/8"*1-3/16"	370
SOC-1032	1-3/16"*1-1/4"	370
SOC-1034	1-1/4"*1-5/16"	380
SOC-1036	1-5/16"*1-3/8"	410
SOC-1038	1-3/8"*1-7/16"	410
SOC-1040	1-7/16"*1-5/8"	450
SOC-1042	1-1/2"*1-9/16"	460
SOC-1044	1-5/8"*1-13/16"	470
SOC-1046	1-13/16"*2"	490
SOC-1048	2"*2-3/16"	510
SOC-1050	2"*2-3/8"	520
SOC-1052	2-3/16"*2-3/8"	530
SOC-1054	2-3/8"*2-3/4"	560



DOUBLE OPEN ENDED SPANNER

Die forged

P/N	S1*S2 mm	L mm	P/N	S1*S2 in	L mm
SNF-0607	6*7	92	SNG-1002	1/4**5/16"	90
SNF-0809	8*9	100	SNG-1004	5/16**3/8"	100
SNF-1011	10*11	115	SNG-1006	3/8**7/16"	110
SNF-1213	12*13	128	SNG-1008	3/8**1/2"	115
SNF-1415	14*15	143	SNG-1010	7/16**1/2"	120
SNF-1617	16*17	157	SNG-1012	1/2**9/16"	130
SNF-1819	18*19	179	SNG-1014	9/16**5/8"	150
SNF-2022	20*22	195	SNG-1016	5/8**11/16"	160
SNF-2123	21*23	200	SNG-1018	5/8**3/4"	165
SNF-2426	24*26	220	SNG-1020	11/16**3/4"	170
SNF-2427	24*27	230	SNG-1022	3/4**13/16"	180
SNF-2528	25*28	236	SNG-1024	3/4**7/8"	185
SNF-3032	30*32	265	SNG-1026	13/16**7/8"	190
SNF-3236	32*36	300	SNG-1028	7/8**15/16"	210
SNF-3436	34*36	300	SNG-1030	15/16**1"	220
SNF-3638	36*38	330	SNG-1032	1**1-1/16"	230
SNF-3641	36*41	330	SNG-1034	1-1/16**1-1/8"	235
SNF-4146	41*46	360	SNG-1036	1-1/8**1-3/16"	245
SNF-4650	46*50	370	SNG-1038	1-3/16**1-1/4"	250
SNF-5055	50*55	385	SNG-1040	1-1/4**1-5/16"	
SNF-1258	1/2"BS*5/8"BS (7/16WW*9/16WW)	300	SNG-1042	1-5/16**1-3/8"	
			SNG-1044	1-3/8**1-7/16"	
			SNG-1046	1-7/16**1-5/8"	
			SNG-1048	1-1/2**1-9/16"	
			SNG-1050	1-5/8**1-13/16"	
			SNG-1052	1-13/16**2"	
			SNG-1054	2**2-3/16"	
			SNG-1056	2**2-3/8"	
			SNG-1058	2-3/16**2-3/8"	
			SNG-1060	2-3/8**2-9/16"	

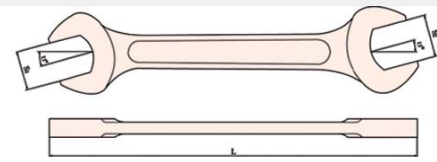



SLOGGING OPEN SPANNER

Die forged

P/N	S mm	L mm
SNA-17	17	125
SNA-19	19	125
SNA-22	22	135
SNA-24	24	150
SNA-27	27	175
SNA-30	30	190
SNA-32	32	190
SNA-34	34	190
SNA-36	36	210
SNA-38	38	210
SNA-41	41	230
SNA-46	46	250
SNA-50	50	275
SNA-55	55	305
SNA-60	60	315
SNA-65	65	335
SNA-70	70	370
SNA-75	75	375
SNA-80	80	400
SNA-85	85	400
SNA-90	90	445
SNA-95	95	445
SNA-100	100	485

P/N	S in	L mm
SNA-1002	3/4"	125
SNA-1004	7/8"	135
SNA-1006	15/16"	150
SNA-1008	1"	175
SNA-1010	1-1/8"	190
SNA-1012	1-1/4"	190
SNA-1014	1-7/16"	210
SNA-1016	1-1/2"	220
SNA-1018	1-5/8"	230
SNA-1020	1-3/4"	250
SNA-1022	1-7/8"	250
SNA-1024	2"	275
SNA-1028	2-1/8"	305
SNA-1030	2-1/4"	315
SNA-1032	2-3/8"	315
SNA-1034	2-1/2"	335
SNA-1036	2-3/4"	370
SNA-1038	3"	375
SNA-1040	3-1/8"	400
SNA-1042	3-1/2"	445
SNA-1044	3-3/4"	445
SNA-1046	4"	485

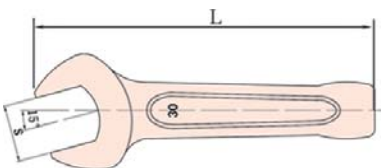



SLOGGING RING SPANNER

Die forged

P/N	S mm	L mm	P/N	S in	L mm
SPZ-17	17	145	SPA-1002	11/16"	145
SPZ-19	19	145	SPA-1004	3/4"	145
SPZ-22	22	155	SPA-1006	7/8"	155
SPZ-24	24	165	SPA-1008	1"	175
SPZ-27	27	175	SPA-1010	1-1/16"	175
SPZ-30	30	185	SPA-1012	1-1/8"	185
SPZ-32	32	185	SPA-1014	1-3/16"	185
SPZ-34	34	200	SPA-1016	1-1/4"	185
SPZ-36	36	205	SPA-1018	1-3/8"	200
SPZ-38	38	215	SPA-1020	1-1/2"	215
SPZ-41	41	225	SPA-1022	1-5/8"	225
SPZ-46	46	235	SPA-1024	1-3/4"	235
SPZ-50	50	250	SPA-1026	1-13/16"	235
SPZ-55	55	265	SPA-1028	2"	250
SPZ-60	60	274	SPA-1030	2-1/16"	
SPZ-65	65	298	SPA-1032	2-3/16"	
SPZ-70	70	320	SPA-1034	2-13/64"	
SPZ-75	75	326	SPA-1036	2-5/16"	
SPZ-80	80	350	SPA-1038	2-3/8"	
SPZ-85	85	355	SPA-1040	2-1/2"	
SPZ-90	90	380	SPA-1042	2-9/16"	
SPZ-95	95	390	SPA-1044	2-5/8"	
SPZ-100	100	410	SPA-1046	2-3/4"	
			SPA-1048	2-15/16"	
			SPA-1050	3"	
			SPA-1052	3-1/16"	
			SPA-1054	3-1/8"	
			SPA-1056	3-3/8"	
			SPA-1058	3-9/16"	
			SPA-1060	3-3/4"	
			SPA-1062	3-15/16"	
			SPA-1064	4-1/8"	

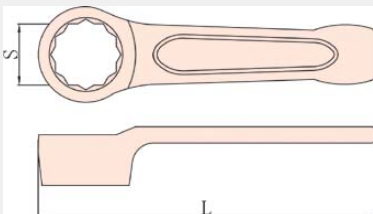



HEX ALLEN KEY

Die forged

P/N	S mm	L mm	H mm
SPF-1.5	1.5	59	25
SPF-2	2	59	25
SPF-2.5	2.5	59	25
SPF-3	3	59	25
SPF-4	4	65	30
SPF-5	5	79	32
SPF-6	6	85	37
SPF-7	7	88	43
SPF-8	8	92	44
SPF-9	9	97	44
SPF-10	10	110	45
SPF-11	11	119	48
SPF-12	12	130	52
SPF-13	13	140	54
SPF-14	14	150	58
SPF-15	15	156	60
SPF-16	16	162	63
SPF-17	17	168	65
SPF-18	18	173	69
SPF-19	19	177	72
SPF-21	21	184	74

P/N	S inch	L mm	H mm
SPG-1002	1/16"	59	25
SPG-1004	5/64"	59	25
SPG-1006	3/32"	59	25
SPG-1008	7/64"	59	25
SPG-1010	1/8"	65	30
SPG-1012	9/64"	79	32
SPG-1014	5/32"	85	37
SPG-1016	3/16"	88	43
SPG-1018	7/32"	92	44
SPG-1020	1/4"	97	44
SPG-1022	9/32"	110	45
SPG-1024	5/16"	119	48
SPG-1026	11/32"	130	52
SPG-1028	3/8"	140	54
SPG-1030	7/16"	150	58
SPG-1032	1/2"	156	60
SPG-1034	9/16"	162	63
SPG-1036	5/8"	168	65

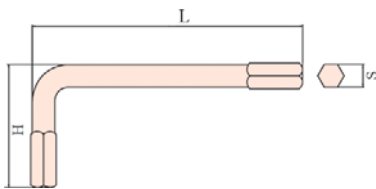



AMERICAN BUNG WRENCH

P/N	L mm	H1 mm	H2 mm
SQI-1002	385	93	61

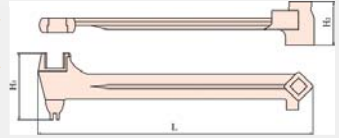

BUNG WRENCH

P/N	L mm	H mm
SQG-1002	300	70

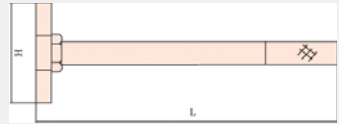

CIRCULAR BUNG WRENCH

Best suited for Indian Customers

P/N	L mm	S1 mm	S2 mm
SQIA-1002	300	38	52

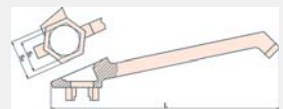

DRUM CUTTER

Q/ZBF-179C Die forged

P/N	Size mm
SQIC-1002	520



DRUM CAP-SEAL CRIMPING TOOL

P/N	□ mm	L mm	Be-Cu g	Al-Br g
SDCS-35	35	390	1320	1150
SDCS-70	70	390	3050	2650



DRUM OPENER PIN TYPE

P/N	S mm	L mm
SQIX-1002A	100	300



DRUM OPENER S-TYPE

P/N	S mm	L mm
SQIY-1002A	73	290

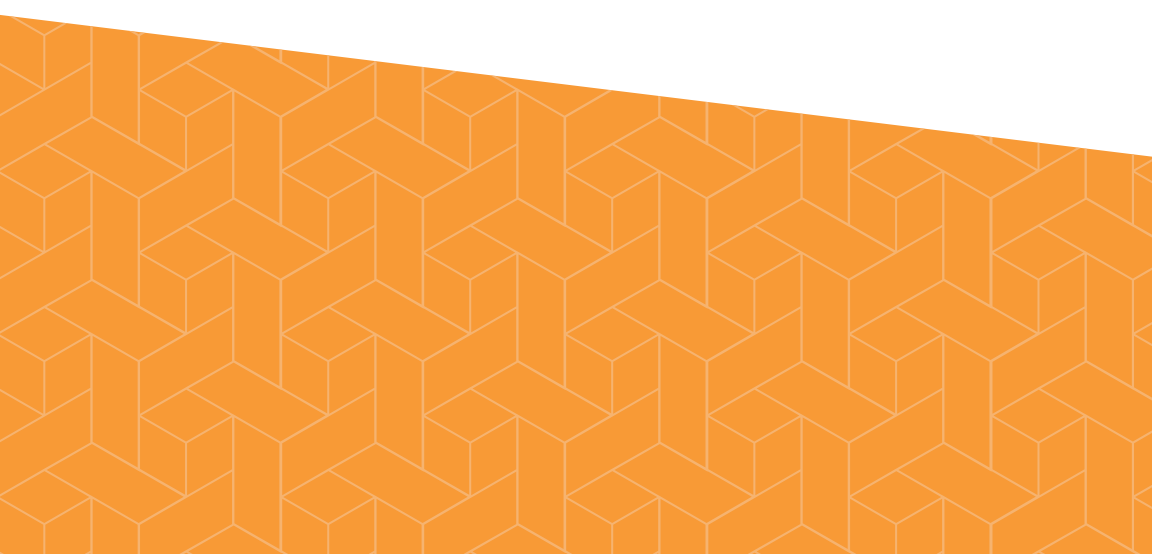



HOOK WRENCH

DIN 1810 Die forged

P/N	D mm	L mm
SQC-1002	30-32mm	140
SQC-1004	34-36mm	170
SQC-1006	40-42mm	176
SQC-1008	45-50mm	209
SQC-1010	52-55mm	212
SQC-1012	58-62mm	244
SQC-1014	68-75mm	250
SQC-1016	80-90mm	284
SQC-1018	95-100mm	288
SQC-1020	110-115mm	337
SQC-1022	120-130mm	343
SQC-1024	135-145mm	388

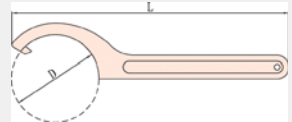

VALVE WRENCH

P/N	S mm	L mm	H mm
SQD-30	30*200mm	200	44
SQD-35	35*250mm	250	49
SQD-40	40*300mm	300	50
SQD-45	45*350mm	350	61
SQD-48	48*375mm	375	62
SQD-50	50*400mm	400	67
SQD-55	55*450mm	450	73
SQD-60	60*500mm	500	79
SQD-65	65*550mm	550	80
SQD-70	70*600mm	600	80
SQD-75	75*650mm	650	85
SQD-80	80*700mm	700	91
SQD-85	85*750mm	750	97
SQD-90	90*800mm	800	103
SQD-93	93*850mm	850	107
SQD-96	96*900mm	900	110
SQD-100	100*1000mm	1000	114
SQD-103	103*1200mm	1200	120

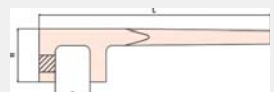



SLEDGE HAMMER

P/N	H g	L mm
SSA-1002	450	310
SSA-1004	1000	400
SSA-1006	1400	400
SSA-1008	1500	400
SSA-1010	1800	400
SSA-1012	2000	400
SSA-1014	2200	400
SSA-1016	2500	700
SSA-1018	2700	700
SSA-1020	3000	700
SSA-1022	3600	700
SSA-1024	4000	900
SSA-1026	4500	900
SSA-1028	5000	900
SSA-1030	5400g	900
SSA-1032	6400g	900
SSA-1034	7200g	900
SSA-1036	8000g	900
SSA-1038	8200g	900
SSA-1040	9100g	900
SSA-1042	9900g	900



BALL PEIN HAMMER

P/N	H g	L mm
SRG-1002	230	280
SRG-1004	340	280
SRG-1006	450	310
SRG-1008	680	340
SRG-1010	910	350
SRG-1012	1130	400



CLAW HAMMER

P/N	H g	L mm
SRE-1002	230g	280
SRE-1004	450g	300
SRE-1006	680g	330
SRE-1008	910g	375



NYLON HAMMER

P/N	H g	L mm
SSAE-1002	800g	340
SSAE-1004	1000g	400



RAILROAD PICK AXE

P/N	Size	H mm	L mm
SSD-1002A	1	360	910
SSD-1004A	2	385	910
SSD-1006A	3	410	910
SSD-1008A	4	470	910

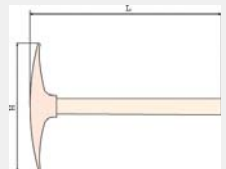

FIREMAN AXE

P/N	L mm	H mm	B mm
SSE-1002	340	145	82

COMMON KNIFE



P/N	L mm	L1 mm
STB-1002	80	185
STB-1004	145	250

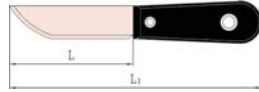

PUTTY KNIFE



P/N	K mm	L mm	L1 mm
STC-1002	25	95	200
STC-1004	40	95	200
STC-1006	50	95	200
STC-1008	65	95	200

SQUARE SHOVEL

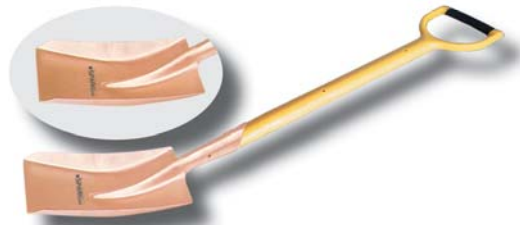

P/N	H mm	Kmm
SSH-1002	63	92
SSH-1004	75	111

EDGING SPADE



P/N	H mm	B mm	H1 mm
STAA-1002B	1390	195	260
STAA-1004B	1440	175	340





DECK SCRAPER

Die forged

P/N	L mm	B mm
STG-1002	250	39
STG-1004	300	45
STG-1006	350	55



FLAT SCRAPER

Die forged



P/N	L mm	B mm	L1 mm
STF-1002	200	30	325
STF-1004	300	30	430
STF-1006	350	35	490
STF-1008	350	50	500



SPRAY BOOTH SCRAPER

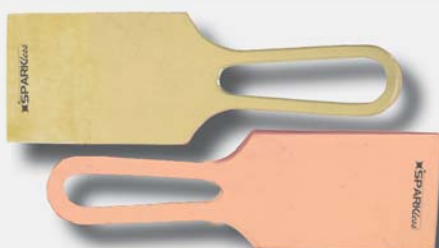

P/N	L mm	B mm
SUA-1002	235	76



SCRAPPER

Q/ZBF-212 Die forged



P/N	L mm	L1 mm	B mm
SUB-1002B	690	90	50
SUB-1004B	705	100	75
SUB-1006B	720	115	100
SUB-1008B	765	150	150





FLAT FILE

Die forged

P/N	L inch	L mm	B mm	H mm
SUG-1002	6	150	16	4
SUG-1004	8	200	21	4.5
SUG-1006	10	250	25	6
SUG-1008	12	300	30	6.5
SUG-1010	14	350	32	8
SUG-1012	16	400	32	9.5

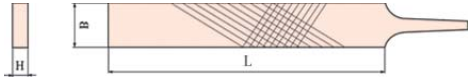

HALF ROUND FILE

Die forged

P/N	L inch	L mm	B mm	H mm
SUH-1002	6	150	22	6
SUH-1004	8	200	23	7
SUH-1006	10	250	26	8
SUH-1008	12	300	28	9
SUH-1010	14	350	30	10
SUH-1012	16	400	30	10

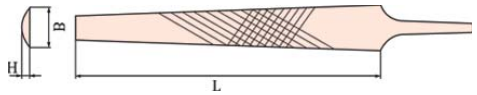

ROUND FILE



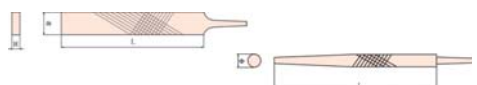

Die forged

P/N	L inch	L mm	Φmm
SUI-1002	6	150	6.5
SUI-1004	8	200	7.5
SUI-1006	10	250	8.5
SUI-1008	12	300	9.5
SUI-1010	14	350	10.5
SUI-1012	16	400	10.5



NEEDLE FILE SET



P/N	Type	L mm	φ mm
SVAA		180	5
		180	5
		180	5
		180	5
		180	5



CROW BAR

Die forged

P/N	L mm	H mm	B mm
SWGC-1002	650	20	23
SWGC-1004	1500	30	25

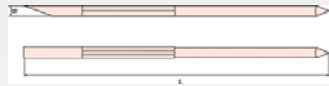

TRIANGLE FILE

Die forged

P/N	L in	L mm	B mm
SVA-1002	8"	200	12
SVA-1004	10"	250	13
SVA-1006	12"	300	14
SVA-1008	14"	350	14
SVA-1010	16"	400	15
SVA-1012	18"	450	16



SQUARE FILE

Die forged

P/N	L in	L mm	B mm
SVZ-1002	8"	200	8
SVZ-1004	10"	250	10
SVZ-1006	12"	300	11
SVZ-1008	14"	350	12
SVZ-1010	16"	400	13
SVZ-1012	18"	450	14





CARBIDE DRUM OPENER

Die forged

P/N	L mm	B mm
SUD-1002	280	53

CRATE OPENER

Die forged

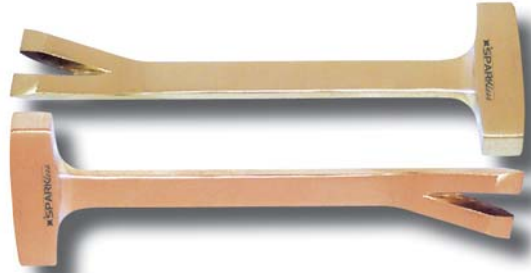

P/N	L mm	H mm
SXA-1002	230	70

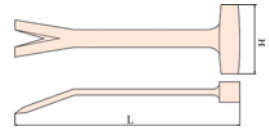

PUNCH

Die forged

P/N	Φ mm	$\Phi 1$ mm	L mm
SVCC-1002	5	11	150
SVCC-1004	6	12	150
SVCC-1006	7	13	150
SVCC-1008	8	14	150

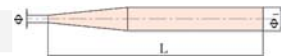

HEARING NEEDLE



P/N	L mm	Φ mm
SWHB-1002	180	3





FLAT CHISEL

Die forged

P/N	B mm	L mm
SVEC-1002	22	150
SVEC-1004	22	200
SVEC-1006	24	250
SVEC-1008	25	300
SVEC-1010	27	400

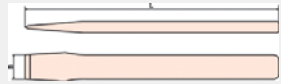

OCTAGONAL CHISEL

Die forged

P/N	L mm	S mm	B mm
SWC-1002	160	14	14
SWC-1004	160	16	16
SWC-1006	180	19	19
SWC-1008	200	19	19
SWC-1010	200	22	22
SWC-1012	250	24	24
SWC-1014	300	24	24
SWC-1016	300	30	30
SWC-1018	400	27	27

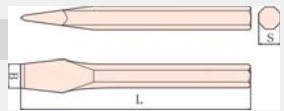

PNEUMATIC CHISEL

Die forged

Best suited for drum barrel cutting.

P/N	S mm	L mm	H mm	B mm
SVI-1002	10	125	2	20
SVI-1004	10	175	2	20

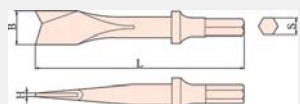



FLANGE WEDGE

Die forged

P/N	L mm	B mm	H mm
SWE-1002	80	13	6
SWE-1004	100	50	10
SWE-1006	135	50	18
SWE-1008	150	40	8
SWE-1010	150	25	8
SWE-1012	150	25	13
SWE-1014	150	50	13
SWE-1016	180	32	13
SWE-1018	180	50	19
SWE-1020	200	20	30
SWE-1022	200	30	30
SWE-1024	200	40	40
SWE-1026	200	50	12
SWE-1028	230	40	20
SWE-1030	250	40	30
SWE-1032	300	50	40

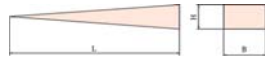

BRUSH



P/N	L*B mm	Rows	H mm
SBE-1002	290*29	4*16	28

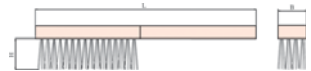

HANDSAW



P/N	L mm	B mm
SABA-1002	700	35

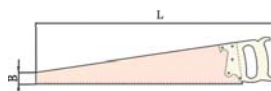



SCISSOR

P/N	L inch	L mm	B mm
SXDA-1002	9	225	98

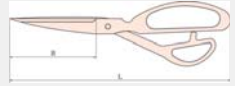

TIN SHEAR

Die forged

P/N	L mm	B mm
SXD-1002	300	75

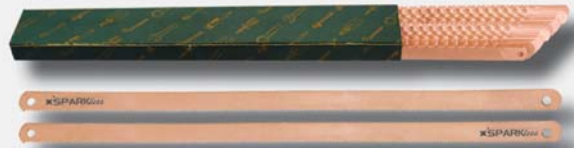
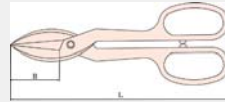

HACKSAW BLADE

P/N	L mm	B mm
SAA-1002	300	12

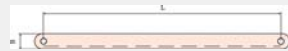

HACKSAW FRAME

P/N	L mm	D mm	H mm
SAZ-1002	500	300	110

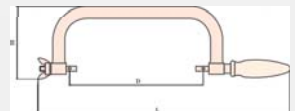

COMBINATION PLIER

Die forged



P/N	L inch	L mm
SXF-1002	6	150
SXF-1004	7	175
SXF-1006	8	200
SXF-1008	10	250

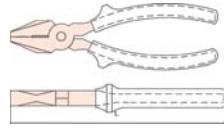

GROOVE JOINT PLIER

Die forged



P/N	L inch	L mm	K max mm
SYA-1002	6	150	25
SYA-1004	10	250	45
SYA-1006	12	300	55
SYA-1008	14	350	55

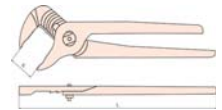

DIAGONAL CUTTING PLIER

Die forged



P/N	L inch	L mm
SXH-1002	6	150
SXH-1004	8	200

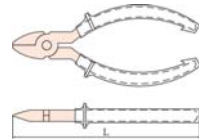

LONG NOSE PLIER

Die forged



P/N	L inch	L mm	L1 mm
SYD-1002	6	150	54
SYD-1004	8	200	74

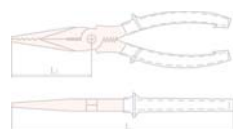

INTERNAL CIRCLIP PLIER

Die forged

P/N	L inch	L mm
SYF-1002	8	200

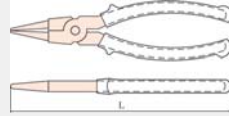

EXTERNAL CIRCLIP PLIER

Die forged

P/N	L inch	L mm
SYG-1002	8	200

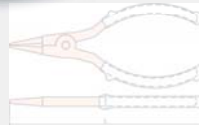

WIRE STRIPPING PLIER

Die forged

P/N	L inch	L mm
SYF-1002	8	200

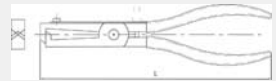

GAS PLIER

P/N	L mm
SXEA-1002	200





BOLT CUTTER

Die forged

P/N	L mm	D mm
SYGA-1002A	600	6
SYGA-1004A	900	8

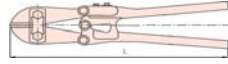

AWL



P/N	L1 mm	Φ mm	L mm
SZI-1002B	100	3	184

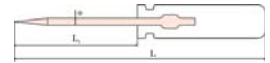

PHILLIPS SCREWDRIVER

P/N	L1 inch	size	L1 mm	L mm	Φ mm
SZA-1002	2	0	50	134	3
SZA-1004	3	1	75	159	4
SZA-1006	4	1	100	205	5
SZA-1008	5	2	125	240	6
SZA-1010	6	2	150	265	6
SZA-1012	8	3	200	327	8
SZA-1014	10	3	250	377	8
SZA-1016	12	4	300	427	9
SZA-1018	14	4	350	477	9
SZA-1020	16	4	400	550	9
SZA-1022	18	4	450	600	9

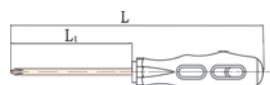



SLOTTED SCREWDRIVER

P/N	L1 inch	L1 mm	L mm	H mm	B mm
SZZ-1002	2	50	134	0.4	3
SZZ-1004	2	50	134	0.5	4.5
SZZ-1006	3	75	159	0.4	3
SZZ-1008	3	75	159	0.5	4
SZZ-1010	3	75	180	0.6	5
SZZ-1012	4	100	184	0.5	4
SZZ-1014	4	100	205	0.6	5
SZZ-1016	4	100	215	0.8	6
SZZ-1018	5	125	240	0.8	6
SZZ-1020	6	150	265	0.8	6
SZZ-1022	6	150	265	1	7
SZZ-1024	6	150	277	1.2	8
SZZ-1026	8	200	327	1.2	8
SZZ-1028	10	250	377	1.4	9
SZZ-1030	10	250	377	2	11
SZZ-1032	12	300	427	1.8	10
SZZ-1034	12	300	427	2	11
SZZ-1036	14	350	477	2	11
SZZ-1038	16	400	550	2.4	12

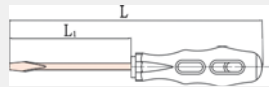

CLAMP

Die forged

P/N	L mm	K mm	B mm
SAD-1002	210	60	36
SAD-1004	250	80	36
SAD-1006	290	100	36
SAD-1008	340	150	50

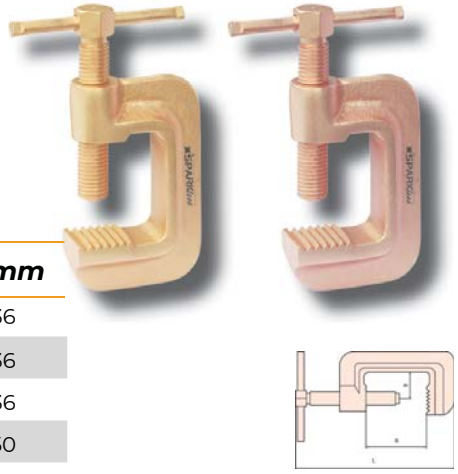

OIL FUNNEL

P/N	Φ mm	H mm
SAH-1002A	169	130
SAH-1004A	160	150

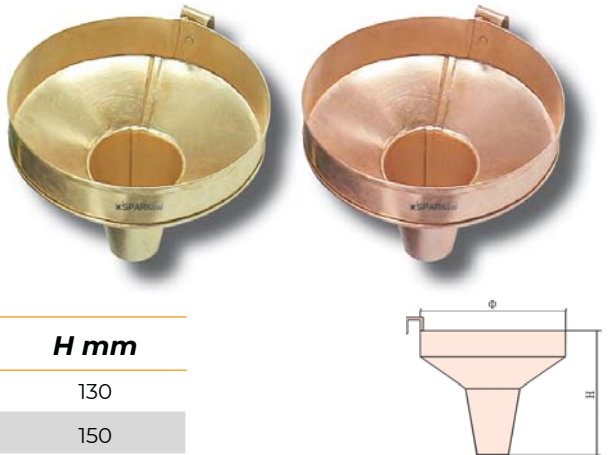

BUCKET

P/N	Size L	H mm
SBAB-1002A	10	250
SBAB-1004A	15	280



FEELER GAUGE

P/N	Size mm
SEI-1002	0.05-1.0



CHAIN HOIST

Die forged

P/N	Capacity T	Lifting m
SDH-1002	0.5	2.5
SDH-1004	1	2.5
SDH-1005	2	2.5
SDH-1006	2	2.5
SDH-1008	3	3
SDH-1010	5	3
SDH-1012	10	3
SDH-1014	16	3

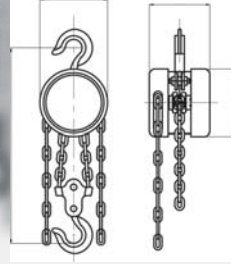

EMERGENCY TOOLKIT OISD 117



P/N	CONTENTS	MEASUREMENTS
	Shoe handle brush	4" x 6"
	Crate opener	9"
	Claw hammer with fiberglass handle	910 g
	Common knife	5 ¾ Blade 10 ¾ OAL
	Groove Joint Plier	12"
	Long nose pliers with cutters	7"
	Combination Pliers	8"
STKA02/ STKB02	Deck scraper	1-1/2" Blade
	Spray booth scraper	3" blade x 9 ¼" long
	Std Screwdriver	5/16" Tip 6" Blade
	Phillips Screwdriver	3"
	Tin Snips	12"
	Adjustable Wrench	8"
	Adjustable Wrench	12"
	Pipe Wrench With Aluminum Handle	14"
	Bung Wrench (Fits ¾" x 2")	12"



TOOL SET - 26 PCS

P/N	CONTENTS	MEASUREMENTS
TKI26	Flat Chisel	18x200 mm
	Adjustable Wrench	150 mm
	Diagonal Plier	200 mm
	Combination Plier	200 mm
	Nose Plier	150 mm
	Phillips Screwdriver	150 mm, 200 mm
	Slotted Screwdriver	150 mm, 200 mm
	Socket 1/2" Dr	8 mm, 10 mm, 12 mm, 14 mm, 17 mm
	Sliding T Handle	1/2", 250 mm
	Hammer	0.15g
	Combination Wrench	8 mm, 10 mm, 12 mm, 14 mm, 17 mm
Hex Allen Key	4 mm, 5 mm, 6 mm, 8 mm, 10 mm	

Emergency ToolKit IOCL

per IOCL CO/HSE/8A/31 Rev-0

P/N	CONTENTS	MEASUREMENTS
STKA01/ STKB01	Crate Opener	230x70mm
	Claw Hammer	450g
	Common Knife	250mm
	Groove Joint Pliers	300mm
	Long Nose Pliers	150mm
	Combination Pliers	200mm
	Deck Scraper	40x250mm
	Scraper	50x690mm
	Scraper	75x705mm
	Scraper	150x765mm
	Spray Booth Scraper	76x235mm
	Flat Screwdriver	8x200mm
	Philips Screwdriver	3:8x200mm
	Cutting Shears	300x75mm
	Adjustable Wrench 8"	24x200mm
	Adjustable Wrench 12"	36x300mm
	Pipe Wrench 14"	50X350 mm
	Bung Wrench	70x300mm
	Flange Wedges	200x30x30mm
	Set of box spanner with ratchet upto 20mm	



21 PCS TOOLKIT

P/N	CONTENTS	MEASUREMENTS
	Flat Chisel	22*150mm
	Adj Wrench	18*150mm
	Combination Plier	8"
	Long Nose Plier	8"
	Phillips Screwdriver	150mm
	Screwdriver	150*8mm
	Screwdriver	200*8mm
	Combination Wrench	8mm
	Combination Wrench	10mm
	Combination Wrench	12mm
TKI21A	Combination Wrench	14mm
	Combination Wrench	17mm
	Allen Key	4mm
	Allen Key	5mm
	Allen Key	6mm
	Allen Key	8mm
	Allen Key	10mm
	Ball Pein Hammer	230g
	Flat Scraper	30*200mm
	Drum Opener (Bung Wrench)	385mm
	ToolBox/ToolBag	



INSULA[®]

Insulated Tools for Electrical Safety

GETSAFE

INDUSTRIAL SAFETY EQUIPMENT

CERTIFICATIONS



VDE

The VDE Testing and Certification Institute is a nationally and internationally accredited institution in the field of testing and certification of electrical engineering devices, components and systems. These electrical products are tested for safety, electromagnetic compatibility and other product properties.



VDE - GS MARK

Technical working equipment and consumable materials subject to the applicable device and product safety laws bear the VDE-GS mark, which stands for the safety of the product with regard to electrical, mechanical, thermal, toxicological, radiological and other dangers. In addition, tools with the VDE-GS mark conform to the VDE regulations or European or internationally harmonised standards, i.e. they confirm the compliance with the safety requirements of the respective guidelines.



DOUBLE TRIANGLE AND VOLTAGE RANGE

If insulated tools or aids are marked with the symbol of the double triangle and the assigned voltage or voltage range specification or the class, they are suitable for working on energised parts at the stated voltage.



IEC 60900

An international standard which, among other things, describes the design of insulated tools in detail. For example, the thickness of the protective insulation is specified. In addition, the standard defines individual tests (piece tests) as well as series and random sample tests for checking the electrical safety of the protective insulation.

SCREWDRIVERS

INSULATED SLOTTED SCREWDRIVER (-)



Tip	Shaft	A	B	CxD	L	PN
0.4	2.5	2.5	75	95x25	170	IC0204
0.5	3.0	3.0	100	95x25	195	IC0205
0.6	3.5	3.5	100	95x25	195	IC0206
0.8	4.0	4.0	100	105x30	205	IC0208
1.0	5.5	5.5	125	115x35	240	IC0210
1.2	6.5	6.5	150	115x35	265	IC0212

  1000V

INSULATED SLIM TYPE SLOTTED SCREWDRIVER (-)



Tip	Shaft	A	B	CxD	L	PN
0.5	3.0	3.0	100	95x25	195	IC0305
0.6	3.5	3.5	100	95x25	195	IC0306
0.8	4.0	4.0	100	105x30	205	IC0308
1.0	5.5	5.5	125	115x35	240	IC0310
1.2	6.5	6.5	150	115x35	265	IC0312

  1000V

INSULATED PHILLIPS SCREWDRIVER



Tip	A	B	CxD	L	PN
PH0	3.0	60	95x25	155	IC0400
PH1	5.0	80	105x30	185	IC0401
PH2	6.0	100	115x35	215	IC0402
PH3	8.0	150	118x41	268	IC0403

  1000V

INSULATED SLIM TYPE PHILLIPS SCREWDRIVER



Tip	A	B	CxD	L	PN
PH1	5.0	80	105x30	185	IC0501
PH2	6.0	100	115x35	215	IC0502
PH3	8.0	150	118x41	268	IC0503

  1000V

INSULATED POZI SCREWDRIVER



☛	A	B	CxD	L	PN
PZ0	3.0	60	95x25	155	IC0600
PZ1	5.0	80	105x30	185	IC0601
PZ2	6.0	100	115x35	215	IC0602
PZ3	8.0	150	118x41	268	IC0603

1000V

INSULATED TX SCREWDRIVER



☛	A	B	CxD	L	PN
T10	3.0	70	95x25	165	IC0810
T15	4.0	80	105x30	185	IC0815
T20	4.0	100	105x30	205	IC0820
T25	5.0	125	115x35	230	IC0825
T30	6.0	130	115x35	245	IC0830

1000V

INSULATED NUT SCREWDRIVER



☛	A	B	E	CxD	L	PN
6.0	7.2	125	31	105x30	230	IC1206
7.0	7.2	125	31	105x30	230	IC1207
8.0	7.2	125	31	105x30	230	IC1208
9.0	7.2	125	31	105x30	230	IC1209
10.0	7.2	125	31	105x30	230	IC1210
11.0	8.1	125	31	118x41	243	IC1211
12.0	8.1	125	31	118x41	243	IC1212
13.0	8.1	125	31	118x41	243	IC1213
14.0	8.1	125	31	118x41	243	IC1214

1000V

INSULATED PRECISION SCREWDRIVER SET

Size	PN
1.5x0.23x50	IC1415
1.8x0.3x50	IC1418
2.0x0.4x50	IC1420
2.5x0.4x50	IC1425
3.0x0.5x50	IC1430
PH00x50	IC1600
PH0x50	IC1601



1000V

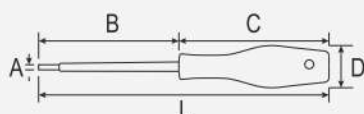

12PC INSULATED CHANGEABLE SCREWDRIVER SET

PN : IC3212



Content

⊖	0.4x2.0x100 0.5x3.0x100 1.0x5.5x100	0.4x2.5x100 0.6x3.5x100 1.2x6.5x100	0.8x4.0x100
---	---	---	-------------

+	PH0x100	PH1x100	PH2x100
---	---------	---------	---------

Voltage Tester: 3.0x70

Handle: 31x105



50PC INSULATED CHANGEABLE SCREWDRIVER SET

PN : IC3450



Content

⊖	0.4x2.0x100 0.6x3.5x100	0.4x2.5x100 0.8x4.0x100	0.5x3.0x100 1.0x5.5x100	1.2x6.5x100
---	----------------------------	----------------------------	----------------------------	-------------

+	PH0x100	PH1x100	PH2x100
---	---------	---------	---------

+	PZ0x100	PZ1x100	PZ2x100
---	---------	---------	---------

⊕	T6x100	T8x100	T9x100	T10x100	T15x100	T20x100	T25x100	T27x100	T30x100
---	--------	--------	--------	---------	---------	---------	---------	---------	---------

⊕	H2.5x100	H3.0x100	H4.0x100	H5.0x100	H6.0x100
---	----------	----------	----------	----------	----------

⊕	R1x100	R2x100
---	--------	--------

⊕	TRI 1x100	TRI 2x100	TRI 3x100	TRI 4x100
---	-----------	-----------	-----------	-----------

+	TORO 4x100	TORO 6x100	TORO 8x100	TORO 10x100
---	------------	------------	------------	-------------

⊕	M4x4.0x100	M5x5.0x100	M6x5.0x100
---	------------	------------	------------

⊕	4x100	6x100	8x100	10x100
---	-------	-------	-------	--------

⊕	M4x4.0x100	M5x5.0x100	M6x5.0x100
---	------------	------------	------------

⊕	6.3x89	8.1x89
---	--------	--------

⊕	89
---	----

⊕	89
---	----

Voltage Tester: 3.0x70

Handle: 31x105



7PC INSULATED SCREWDRIVER SET

PN : IC2408



Content

	2.5X75X100	4X100X100	5.5X125X100
	PH0x100	PH1x100	PH2x100
	Line Tester 1 Pc		
	Handle: 31x105		

1000V

PLIERS

INSULATED COMBINATION PLIER

mm			PN
160	2.0	1.6	DA0116
200	2.5	2.2	DA0120

1000V



INSULATED SNIPE NOSE SIDE CUTTING PLIER

mm			PN
160	2.0	1.6	DA0316
200	2.4	2.0	DA0320

1000V



INSULATED CURVED NOSE CUTTING PLIER

mm			PN
160	2.0	1.6	DA0516
200	2.4	2.0	DA0520

1000V



INSULATED DIAGONAL CUTTING PLIER

mm			PN
160	2.0	1.6	DA0716

   1000V



INSULATED HEAVY DUTY DIAGONAL CUTTING PLIER

mm			PN
180	2.0	1.6	DA0718

   1000V



INSULATED WIRE STRIPPER

mm	mm	 mm ²	PN
160	5.0	10.0	DA1316

   1000V



INSULATED CABLE SHEAR

mm	 mm	mm ²	PN
250	250	80	DA1725

   1000V



INSULATED RATCHETING CABLE CUTTER

 mm (Max)	mm ² (Max)	PN
32	240	IA2024
52	380	IA2038

   1000V



INSULATED PLASTIC CLAMP

mm	PN
200	IF1020

   1000V



INSULATED ROUND NOSE PLIER

mm ² (Max)	PN
160mm	DA0920

   1000V



INSULATED FLAT NOSE PLIER

mm ² (Max)	PN
160mm	DA1116

   1000V



WRENCHS

INSULATED OPEN WRENCH



S	A	B	L	PN
6	7.0	22	90	DD0106
7	7.0	24	90	DD0107
8	7.5	25.5	100	DD0108
9	7.5	27.5	100	DD0109
10	8.0	29	110	DD0110
11	8.5	31	110	DD0111
12	8.5	33	130	DD0112
13	10.5	34	135	DD0113
14	10.5	37	145	DD0114
15	11.5	40	150	DD0115
16	11.5	42	160	DD0116
17	12.0	44	160	DD0117
18	12.0	44.5	175	DD0118
19	12.5	48	175	DD0119
21	12.5	51	195	DD0121
22	13.0	54	195	DD0122
24	13.5	56	225	DD0124
27	14.8	61	250	DD0127
30	14.8	66	290	DD0130
32	15.8	70	310	DD0132



⚡ 1000V



INSULATED RING WRENCH



S	A	B	L	PN
6	7.0	22	90	DD0306
7	7.0	24	90	DD0307
8	7.5	25.5	100	DD0308
9	7.5	27.5	100	DD0309
10	8.0	29	110	DD0310
11	8.5	31	110	DD0311
12	8.5	33	130	DD0312
13	10.5	34	135	DD0313
14	10.5	37	145	DD0314
15	11.5	40	150	DD0315
16	11.5	42	160	DD0316
17	12.0	44	160	DD0317
18	12.0	44.5	175	DD0318
19	12.5	48	175	DD0319
21	12.5	51	195	DD0321
22	13.0	54	195	DD0322
24	13.5	56	225	DD0324
27	14.8	61	250	DD0327
30	14.8	66	290	DD0330
32	15.8	70	310	DD0332



⚡ 1000V

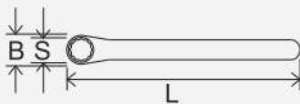
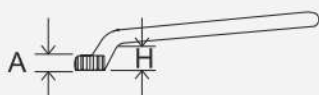

INSULATED ADJUSTABLE WRENCH



mm	S (Max)mm	PN
200	24	DD0520
250	28	DD0525
300	32	DD0530

1000V

INSULATED ALLEN KEY



mm	⊠ (mm)	PN
130	3	DD2503
140	4	DD2504
160	5	DD2505
180	6	DD2506
200	8	DD2508
235	10	DD2510
260	12	DD2512

1000V

INSULATED HEX KEY T-TYPE WITH BALL END

⊠	D	L	H	PN
3	15	150	95	ID0703
4	15	150	95	ID0704
5	15	150	95	ID0705
6	15	150	95	ID0706
8	15	150	95	ID0708

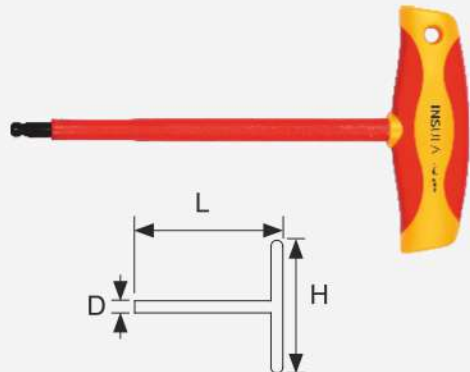

1000V

SOCKETS & ACCESSORIES

INSULATED ADAPTER

Size (mm)	H	PN
1/2" (Female) to 3/8" (Male)	77	DD1238
3/8" (Female) to 1/2" (Male)	72	DD3812



INSULATED Z TYPE ADAPTER 3/8"

PN : DD4038



INSULATED ALLEN SOCKET

□	L (mm)	D	PN
1/4"	66	3	IS0802
	66	4	IS0803
	66	5	IS0804
	66	6	IS0805
	66	8	IS0806
3/8"	120	4	DD1904
	120	5	DD1905
	120	6	DD1906
	120	8	DD1908
1/2"	120	4	DD1704
	120	5	DD1705
	120	6	DD1706
	120	8	DD1708
	120	10	DD1710

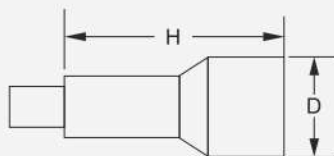

INSULATED SOCKET

□	Size (mm)	D	PN
3/8"	6	14.5	DD1506
	7	16	DD1507
	8	17	DD1508
	9	18	DD1509
	10	20	DD1510
	11	21	DD1511
	12	23	DD1512
	13	23.5	DD1513
	14	25	DD1515
	15	26	DD1514
	16	27	DD1516
	17	28.5	DD1517
	18	30	DD1518
	19	31	DD1519
20	33	DD1520	
21	33	DD1521	
22	35	DD1522	
1/2"	10	18.7	DD1310
	11	20.0	DD1311
	12	21.2	DD1312
	13	22.3	DD1313
	14	23.7	DD1314
	16	26.4	DD1316
	17	26.7	DD1317
	18	28.7	DD1318
	19	29.0	DD1319
	21	31.0	DD1321
	22	33.0	DD1322
	24	35.3	DD1324
27	40.0	DD1327	
30	43.1	DD1330	
32	45.1	DD1332	

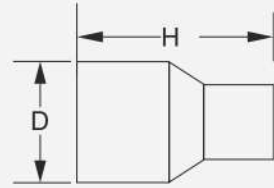

1000V

INSULATED TORX SOCKET

Sq Dr	mm (hex)	L (mm)	PN
1/4"	T10	66	IST2010
	T15	66	IST1015
	T20	66	IST1020
	T25	66	IST1025
	T27	66	IST1027
	T30	66	IST1030
	T40	66	IST1040
	3/8"	T10	75
T15		75	TS3815
T20		75	TS3820
T25		75	TS3825
T27		75	TS3827
T30		75	TS3830
T40		75	TS3840
T45		75	TS3845
T50		75	TS3850
T55	75	TS3855	



1000V

INSULATED DEEP SOCKET

□	mm (hex)	D1 (mm)	D2 (mm)	L (mm)	PN
1/4"	4mm	12	18	67	ISDH0104
	5mm	13	18	67	ISDH0105
	6mm	14	18	67	ISDH0106
	7mm	16	18	67	ISDH0107
	8mm	18	18	67	ISDH0108
	9mm	18	18	67	ISDH0109
	10mm	19	18	67	ISDH0110
	11mm	21	18	67	ISDH0111
	12mm	22	18	67	ISDH0112
	13mm	23	18	67	ISDH0113



INSULATED BI-HEX DEEP SOCKET

□	mm (hex)	D1 (mm)	D2 (mm)	L (mm)	PN
3/8"	8mm	17	23	80	DS3808
	10mm	20	23	80	DS3810
	12mm	22	23	80	DS3812
	14mm	25	23	80	DS3814
	15mm	26	23	80	DS3815
	17mm	28.5	23	80	DS3817
	19mm	31	23	80	DS3819
	22mm	35	23	80	DS3822



⚡ 1000V

INSULATED RATCHET WRENCH

□	mm	PN
1/4"	145	Dd2114
3/8"	200	DD2138
1/2"	250	DD2112



⚡ 1000V

INSULATED EXTENSION BAR

□	mm	PN
1/4"	75	DD2305
	150	DD2306
3/8"	125	DD2303
	250	DD2304
1/2"	125	DD2301
	250	DD2302



⚡ 1000V

INSULATED L- HANDLE

	mm	PN
1/2"	270	DD2812

 1000V



INSULATED T- HANDLE

	mm	H	PN
3/8"	200	155	DD1138
1/2"	200	155	DD1112

 1000V



INSULATED SOCKET WRENCH

Hex I	D	L	H	PN
8	15.0	200	145	DD0908
10	19.5	300	145	DD0920
12	22.0	300	145	DD0922
13	23.5	300	145	DD0923
14	24.5	300	145	DD0924
16	27.0	300	145	DD0926
17	28.5	300	145	DD0927
18	29.5	300	145	DD0928
19	31.0	300	145	DD0929

 1000V

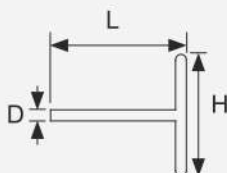

INSULATED TORQUE WRENCH

	N.m	PN
1/4"	5-25	ID1002
3/8"	5-25	ID2008
	10-50	ID2012
	20-100	ID2016
1/2"	10-50	ID3012
	20-100	ID3016
	40-200	ID3020

 1000V



KNIFES

INSULATED CABLE KNIFE (STRAIGHT)

mm	D	PN
180	50	IE0418



INSULATED DISMANTLING KNIFE (SEMI-CIRCLE)

mm	D	PN
155	28	IE0616



INSULATED DISMANTLING KNIFE (LONG HOOK)

mm	D	PN
180	50	IE1018



INSULATED CABLE KNIFE (GUARD)

mm	D	PN
180	50	IE1218



INSULATED DISMANTLING KNIFE

mm	D	PN
155	38	IE1416

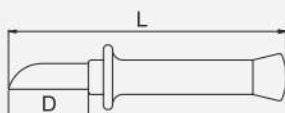

ACCESSORIES

INSULATED HACKSAW FRAME

D	L	PN
150	300	IE0230
300	483	IE0240

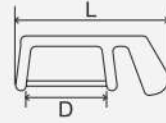

INSULATED MALLET

mm	Φ mm	Wt/ kg	PN
315	30	0.6	IG1030



INSULATED TWEEZER

mm	PN
130	IF0213



INSULATED GLOVES



TOOL SETS

INSULATED BATTERY TOOLKIT

PN : IH0815

4 Screwdriver bits	PH2, PH1, F5, F4
2 in 1 Bits holder	(for the above bits)
Open Wrench	8mm, 10mm, 13mm
T- Handle	3/8"
Ring Wrench	8mm, 10mm, 13mm
Sockets 3/8"	8mm, 10mm, 13mm



25PC INSULATED TOOLKIT

PN : IH0825



Content	mm
Combination Plier	200
Diagonal Plier	160
6Pcs Screwdriver	PH: PH0x60, PH1x80, PH2x100 SL: 0.6X3.5X100, 0.8X4.0X100, 1.0X5.5X125
Cable Knife(Straight)	50x180
Cable Knife(Semicircle)	28x155
7Pcs 1/2" Sockets	10, 11, 12, 13, 14, 17, 19
7Pcs 1/2" Open End Wrench	10, 11, 12, 13, 14, 17, 19
T-Handle	1/2"

1000V

31PC INSULATED TOOLKIT

PN : IH0831



Content	mm
Combination Plier	200
Diagonal Plier	160
6Pcs Screwdriver	PH: PH0x60, PH1x80, PH2x100 SL: 0.6X3.5X100, 0.8X4.0X100, 1.0X5.5X125
Cable Knife(Straight)	50x180
Cable Knife(Semicircle)	28x155
7Pcs Sockets	10, 11, 12, 13, 14, 17, 19
7Pcs Open End Wrench	10, 11, 12, 13, 14, 17, 19
Insulated T-Handle	1/2"
Insulated Allen Key	3, 4, 5, 6, 8, 10

1000V

20PC INSULATED RING WRENCH SET

PN : DD CS-06

6mm, 7mm, 8mm, 9mm, 10mm, 11mm,
12mm, 13mm, 14mm, 15mm, 16mm, 17mm,
18mm 19mm, 21mm, 24mm, 27mm, 30mm,
32mm

1000V



20PC INSULATED OPEN WRENCH SET

PN : DD CS-05

6mm, 7mm, 8mm, 9mm, 10mm, 11mm,
12mm, 13mm, 14mm, 15mm, 16mm,
17mm, 18mm 19mm, 21mm, 24mm,
27mm, 30mm, 32mm

1000V

52PC INSULATED TOOLKIT

PN IH1852

Content

A Tray

B Tray

C Tray

D Tray



INSULATED A TRAY PN IH1946

Content

- 6 pcs Pliers
- 7" Combination Pliers
- 8" Long Nose Pliers
- 6" Diagonal Cutter
- 6" Stripping Pliers
- 10" Water Pump Pliers
- 6" Cable Cutter



INSULATED B TRAY PN IH1947

Content

- 11 pcs Screwdrivers, Knife & Tester
- PH0X60, PH1X80, PH2X100, PH3X150
- 2.5x75mm, 3x100mm, 4x100mm, 5.5x125mm, 6.5x150mm
- Straight Knife
- Voltage Tester



INSULATED C TRAY PN IH1948

Content

- 21 pcs 1/2" Sockets and Accessory
- Sockets Bits: 4, 5, 6, 8mm
- Sockets: 10/ 11/ 12/ 13/ 14/ 16/ 17/ 18/ 19/ 21/ 22/ 24/ 27
- Extension Bar 5" & 10"
- T Handle
- Ratchet Handle



INSULATED D TRAY PN IH1949

Content

- 14 pcs Open Wrenches and Adjustable Wrenches
- Open Wrench: 8/ 10/ 11/ 12/ 13/ 14/ 15/ 16/ 17/ 18/ 19/ 22/ 24
- 8" Adjustable Wrench



INSULATED TOOLKIT TROLLEY

PN : IHO169

Drawers Trolley with Foam Profiles

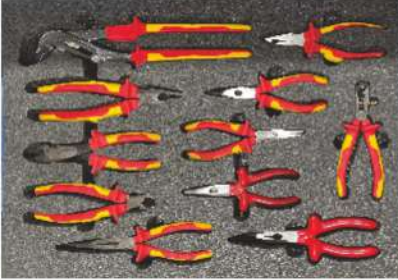

Description	mm
Screwdriver (6)	0.4*2.5*75, 0.5*3.0*100, 0.6*3.5*100, 0.8*4.0*100, 1.0*5.5*125, 1.2*6.5*150
Phillips Screwdriver (4)	PH0*60, PH1*80, PH2*100, PH3*150
Pozi Screwdriver (4)	PZ0*60, PZ1*80, PZ2*100, PZ3*150
TX Screwdriver (5)	T10*70, T15*80, T20*100, T25*125, T30*130
Precision Screwdriver (5)	1.5*0.23*50, 1.8*0.30*50, 2.0*0.40*50, 2.5*0.40*50, 3.0*0.50*50
Precision Philips Screwdriver (2)	PH00*50, PH0*50
Nut Screwdriver (9)	6.0*125, 7.0*125, 8.0*125, 9.0*125, 10*125, 11*125, 12*125, 13*125, 14*125
Open Wrench (20)	6, 7, 8, 9, 10, 11, 12, 13, 14, 15, 16, 17, 18, 19, 21, 22, 24, 27, 30, 32
Ring Wrench (20)	6, 7, 8, 9, 10, 11, 12, 13, 14, 15, 16, 17, 18, 19, 21, 22, 24, 27, 30, 32
Adj Wrench (3)	200, 250, 300
Allen Key (7)	3, 4, 5, 6, 8, 10, 12
Hex Key T-Type (5) With Ball End	3*150, 4*150, 5*150, 6*150, 8*150
Socket 3/8" (17)	6, 7, 8, 9, 10, 11, 12, 13, 15, 14, 16, 17, 18, 19, 20, 21, 22
Allen Socket 3/8" (4)	4*75, 5*75, 6*75, 8*75
Ratchet Wrench (1)	3/8"*200
Extension (2)	3/8"*125, 3/8"*250



T-Handle (1)	3/8"200
Socket Wrench (9)	8*200, 10*300, 12*300, 13*300, 14*300, 16*300, 17*300, 18*300, 19*300
Socket 1/2" (15)	10, 11, 12, 13, 14, 16, 17, 18, 19, 21, 22, 24, 27, 30, 32
Allen Socket 1/2" (5)	4*120, 5*120, 6*120, 8*120, 10*120
Ratchet Wrench (1)	1/2"*250
Extensions (2)	1/2"*125, 1/2"*250
L-Handle (1)	1/2"*250
T-Handle (1)	1/2"*200
Combination Plier (2)	160, 200
Snipe Nose Side Cutting Plier (2)	160, 200
Curved Nose Cutting Plier (2)	160, 200
Diagonal Plier (1)	160
Heavy Duty Diagonal Plier (1)	180
Flat Nose Plier (1)	160
Wire Stripper (1)	160
Water Pump Plier (1)	300
Hacksaw Frame (1)	150
Cable Knife(Straight)	
Dismantling Knife(Semicircle)	
Dismantling Knife(Long Hook)	
Cable Knife(Guard)	
Dismantling Knife	
Fluke Multimeter	
Fluke Clampmeter	
Insulated Gloves Class 0	

42PC Insulated Mobile Tool Trolley

PN : IHO841



Description	mm
Open Wrench (7)	8, 10, 11, 12, 13, 14, 17
Ring Wrench (7)	8, 10, 11, 12, 13, 14, 17
1/2" Socket (9)	8, 10, 11, 12, 13, 14, 17, 19, 22
Allen Key (6)	3, 4, 5, 6, 8, 10
T-Handle (1)	12"*200
Phillips Screwdriver (3)	PH0*60, PH1*180, PH2*100
Slotted Screwdriver (3)	0.6*3.5*100, 0.8*4.0*100, 1.0*5.5*125
Dismantling Knife (Semicircle)	
Cable Knife (Straight)	
Combination Plier	160
Diagonal Plier	160
Wire Stripper	160
Adj Wrench	200
Hand Gloves 1.1Kv	

Insulated Socket Set 1/2" Sq Dr

1000V VDE Insulated Tools Includes:

PN : DDC1201



Description	mm
1/2 Insulated Socket (15)	10, 11, 12, 13, 14, 16, 17, 18, 19, 21, 22, 24, 27, 30, 32
Insulated Allen Socket (5)	1/2" 4, 5, 6, 8, 10
Insulated Ratchet Wrench (1)	1/2" 250
Insulated Extension Bar (1)	1/2" 125, 250
Insulated T-Handle (1)	1/2" 200

Insulated Socket Set 3/8" Sq Dr

1000V VDE Insulated Tools Includes:

PN : DDC3801



Description	mm
3/8 Insulated Socket (14)	8, 10, 11, 12, 13, 14, 15, 16, 17, 18, 19, 20, 21, 22
Insulated Allen Socket (5)	4, 5, 6, 8
Insulated Ratchet Wrench (1)	200
Insulated Extension Bar (2)	125, 250
Insulated T-Handle (1)	200

**BOMBAY
TOOLS** YOUR
INDUSTRIAL
PARTNER



Stainless Steel Tools

For critical environments
& non-magnetic application.

STERILA

*Stainless Steel Hand Tools
SS304 & SS316*

the
tools
expert

Wrenches



Combination Wrench

Product No.	mm
SSJAA-6	6mm
SSJAA-7	7mm
SSJAA-8	8mm
SSJAA-9	9mm
SSJAA-10	10mm
SSJAA-11	11mm
SSJAA-12	12mm
SSJAA-13	13mm
SSJAA-14	14mm
SSJAA-15	15mm
SSJAA-16	16mm
SSJAA-17	17mm

Product No.	mm
SSJAA-18	18mm
SSJAA-19	19mm
SSJAA-20	20mm
SSJAA-21	21mm
SSJAA-22	22mm
SSJAA-23	23mm
SSJAA-24	24mm
SSJAA-25	25mm
SSJAA-26	26mm
SSJAA-27	27mm
SSJAA-30	30mm
SSJAA-32	32mm



D/E Open Wrench

Product No.	mm
SSJBA-0607	6*7mm
SSJBA-0809	8*9mm
SSJBA-1011	10*11mm
SSJBA-1213	12*13mm
SSJBA-1415	14*15mm
SSJBA-1617	16*17mm
SSJBA-1819	18*19mm
SSJBA-2022	20*22mm

Product No.	mm
SSJBA-2123	21*23mm
SSJBA-2426	24*26mm
SSJBA-2427	24*27mm
SSJBA-2528	25*28mm
SSJBA-3032	30*32mm



D/E Ring Wrench

Product No.	mm
SSJGA-0607	6*7mm
SSJGA-0809	8*9mm
SSJGA-1011	10*11mm
SSJGA-1213	12*13mm
SSJGA-1415	14*15mm
SSJGA-1617	16*17mm
SSJGA-1819	18*19mm
SSJGA-2022	20*22mm

Product No.	mm
SSJGA-2123	21*23mm
SSJGA-2426	24*26mm
SSJGA-2427	24*27mm
SSJGA-2528	25*28mm
SSJGA-3032	30*32mm



Adj Wrench

Product No.	mm
SSKE-1004	18*150mm
SSKE-1006	24*200mm
SSKE-1008	30*250mm
SSKE-1010	36*300mm

Product No.	mm
SSKE-1012	46*375mm
SSKE-1014	55*450mm
SSKE-1016	65*600mm



Pipe Wrench

Product No.	mm
SSKFA-1002	250mm
SSKFA-1004	300mm
SSKFA-1006	350mm

Product No.	mm
SSKFA-1008	450mm
SSKFA-1010	600mm

Allen Key



Allen Key

Product No.	mm
SSLZ-1.5	1.5mm
SSLZ-2	2mm
SSLZ-2.5	2.5mm
SSLZ-3	3mm
SSLZ-4	4mm
SSLZ-5	5mm
SSLZ-6	6mm
SSLZ-7	7mm
SSLZ-8	8mm
SSLZ-9	9mm
SSLZ-10	10mm
SSLZ-12	12mm
SSLZ-14	14mm

Product No.	mm
SSLZ-1002	1/16"
SSLZ-1004	5/64"
SSLZ-1006	3/32"
SSLZ-1010	1/8"
SSLZ-1014	5/32"
SSLZ-1016	3/16"
SSLZ-1018	7/32"
SSLZ-1020	1/4"
SSLZ-1024	5/16"
SSLZ-1028	3/8"
SSLZ-1030	7/64"
SSLZ-1032	9/64"



T-Allen Key Ball End

Product No.	mm
SSLZA-1002	3mm
SSLZA-1004	4mm
SSLZA-1006	5mm
SSLZA-1008	6mm

Product No.	mm
SSLZA-1010	7mm
SSLZA-1012	8mm
SSLZA-1014	9mm
SSLZA-1016	10mm

Screwdriver



Phillips Screwdriver With SS Handle

Product No.	mm
SSTC-1002	3*50mm
SSTC-1004	4*75mm
SSTC-1006	5*100mm
SSTC-1008	6*150mm

Product No.	mm
SSTC-1010	8*200mm
SSTC-1012	9*250mm
SSTC-1014	10*300mm



Slotted Screwdriver With SS Handle

Product No.	mm
SSTD-1002	50mm
SSTD-1004	75mm
SSTD-1006	100mm
SSTD-1008	150mm

Product No.	mm
SSTD-1010	200mm
SSTD-1012	250mm
SSTD-1014	300mm

Plier

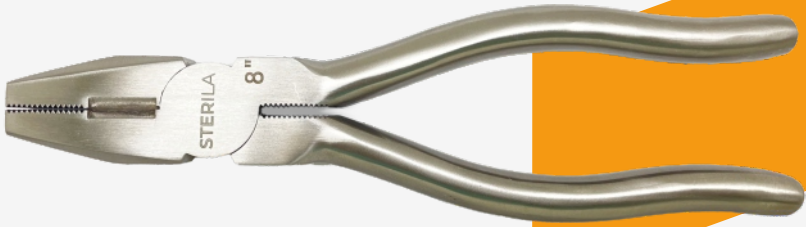

Combination Plier With SS Handle

Product No.	mm
SSEA-1002	150mm
SSEA-1006	200mm



Diagonal Cutting Plier With SS Handle

Product No.	mm
SSTC-1002	150mm
SSTC-1004	190mm



Mini Plier

Product No.	mm
SSTC-1002	150mm



Long Nose Plier With SS Handle

Product No.	mm
SSEB-1002	165mm
SSEB-1006	200mm

Hammer



Ball Pein Hammer With SS Handle

Product No.	mm
SSNAA-1002	230g
SSNAA-1006	450g



Nylon Hammer With SS Handle

Product No.	mm
SSOC-1002	800g
SSOC-1004	1000g

OUR PRODUCT VERTICALS

GET SAFE

INDUSTRIAL SAFETY EQUIPMENT

MEASURE UP

MEASURING EQUIPMENT FOR INDUSTRIAL NEEDS

TOOL IT

TOOLS FOR ASSEMBLY, OPERATION & MAINTENANCE

Authorised Partner/ Retailer

BOMBAY TOOLS





Scan the QR code for more Variants

Bombay Tools Centre (Bombay) Pvt. Ltd.

A-407, Byculla Services Industries CHS, Dadoji Konddeo Cross Ln, Byculla East, Mumbai 400027

+91 85913 06264

info@bombaytools.in

Follow us on:   

www.thebombaytools.com

